

# CUT-Line



APPLITEC

**Applitec Moutier S.A.**  
Ch. Nicolas-Junker 2  
CH-2740 Moutier



**APPLITEC**  
SWISS TOOLING

Tél. +41 32 494 60 20  
Fax +41 32 493 42 60  
[www.applitec-tools.com](http://www.applitec-tools.com)

# CUT-Line

APPLITEC

Porte-outils / Halter / Holders

**H**

Système de serrage à bride - version courte  
Spannbrücke Klemmsystem kurze Ausführung  
Independent top clamp system, short version

**HX**

Système de serrage à bride - version longue  
Spannbrücke Klemmsystem lange Ausführung  
Independent top clamp system, long version

**HZ**

Porte-outil de grande capacité  
Klemmhalter für grössere Durchmesser  
High capacity tool holder

*Very rigid clamping system!*

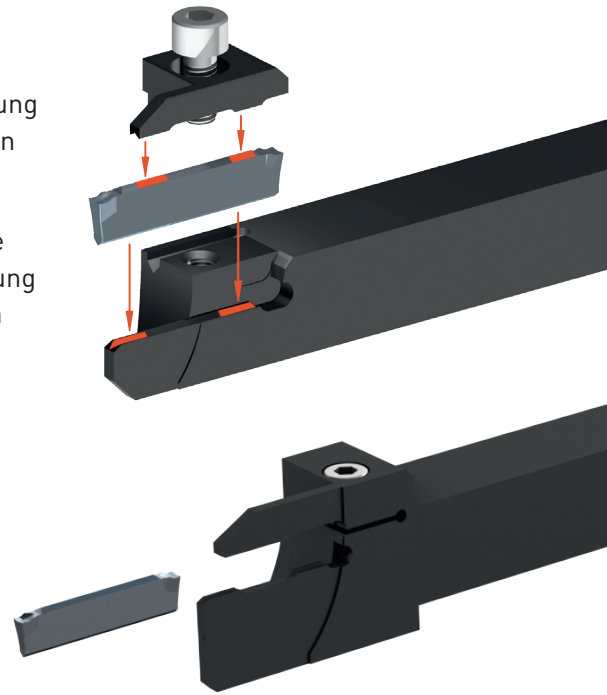

Plaquettes / WSP / Inserts

**CUT 16**

=

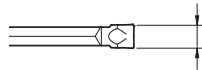

1.6 mm

Ø max 20 mm

**CUT 22**

=

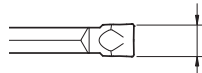

2.2 mm

Ø max 42 mm

**CUT 31**

=

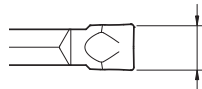

3.1 mm

Ø max 65 mm

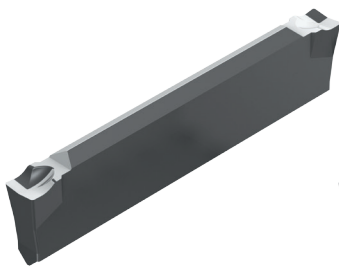

**U**

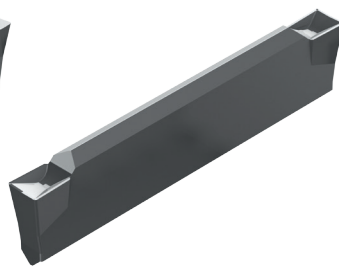

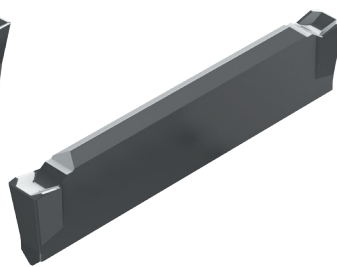

**P**

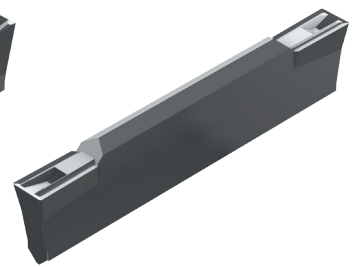

**T**



**G**

Nuances et géométries Sorten und Geometrien Grades and types of geometries		> 2
	<b>CUT 16</b> Ø max 20 mm	> 4
Paramètres de coupe indicatifs Empfohlene Schnittwerte Standard machining data	<b>CUT 22</b> Ø max 42 mm	> 6
	<b>CUT 31</b> Ø max 65 mm	> 8
	<b>H Series</b>	> 10
Porte-outils Halter Holders	<b>HX Series</b>	> 11
	 <b>HZ Series</b>	> 12
Porte-outils avec arrosage intégré Halter mit integriertem Kühlmittelzufuhr Holder with integrated coolant supply	 <b>HZ-JET Series</b>	> 13
	<b>U Series</b>	> 14
Plaquettes de tronçonnage Abstechwendeplatten Cut off inserts	 <b>P Series</b>	> 16
	<b>T Series</b>	> 18
Plaquettes de fonçage, tournage et tronçonnage WSP zum einstecken, drehen und abstechen Inserts for grooving, turning and cut off	<b>G Series</b>	> 19

## TiALN

revêtement PVD  
PVD Beschichtung  
PVD coating

- pour l'usinage des aciers, aciers inoxydables et alliages de titane
- 1<sup>er</sup> choix pour les avances faibles à modérées

- für die Bearbeitung von Stahl, rostfreiem Stahl und Titanlegierungen
- beste Wahl für niedrige bis mittlere Vorschübe

- for machining of steel, stainless steel and titanium alloys
- first choice for low to average cutting speed

## Tmax

revêtement PVD  
PVD Beschichtung  
PVD coating

- nuance pour usinage moyen à lourd des aciers, aciers alliés et inoxydables
- bonne résistance aux températures d'usinage élevées
- 1<sup>er</sup> choix pour le tronçonnage des aciers au carbone et des aciers fortement alliés

- Sorte für mittlere bis hohe Belastung in Stahl und legierter Stahlbearbeitung
- gute Bearbeitungswarmfestigkeit
- bestens geeignet für die Bearbeitung von legiertem Kohlenstahl und hoch legiertem Stahl

- grade for medium to heavy machining of steel, stainless steel and alloyed steel
- high machining heat resistance
- first choice for the machining of carbon steel and high alloyed steel

**NEW**

## Zmax

revêtement PVD  
PVD Beschichtung  
PVD coating

- pour l'usinage des aciers, aciers inoxydables et alliages de titane en conditions défavorables
- bonne résistance aux chocs à des vitesses de coupe moyenne à faible
- 1<sup>er</sup> choix pour le tronçonnage en coupe interrompue

- für die Bearbeitung von Stahl, rostfreiem Stahl und Titanlegierungen in schwierige Bearbeitungsfälle
- gute Bruchfestigkeit mit durchschnittliche bis niedrige Schnittgeschwindigkeit
- für die Bearbeitung in unterbrochenen Schnitte bestens geeignet

- for machining of steel, stainless steel and titanium alloys in unfavourable machining conditions
- good impact resistance with average to low cutting speed
- first choice for machining in interrupted cut

## HTA

revêtement PVD  
PVD Beschichtung  
PVD coating

- très bonne résistance à l'usure
- pour le tronçonnage des aciers, aciers inoxydables et alliages de titane
- déconseillé en coupe interrompue

- sehr gute Verschleissfestigkeit
- für die Bearbeitung von Stahl, rostfreiem Stahl und Titanlegierung bestens geeignet
- für unterbrochene Schnitte ungeeignet

- very good wear resistance
- first choice for steel, stainless steel and titanium alloys machining
- not suitable for interrupted cut

## AS

revêtement PVD  
PVD Beschichtung  
PVD coating

- nuance pour métaux non ferreux
- très faible coefficient de frottement
- 1<sup>er</sup> choix pour l'usinage des aluminiums jusqu'à 5% Si, des cuivres et titanes faiblement alliés

- Sorte für Nichteisenmetalle
- sehr geringer Reibwert
- für die Bearbeitung von Aluminium bis 5% Si, Kupfer und niedriglegiertem Titan bestens geeignet

- grade for non-ferrous materials
- very low friction ratio
- first choice for Aluminium up to 5% Si, Copper and low alloyed Titanium

Géométries de coupe

Spanformgeometrie

Cutting geometries

UN

UR  
UL

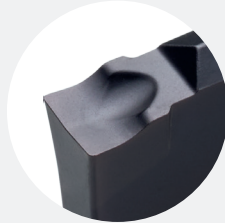

- Géométrie positive universelle, bonne maîtrise du copeau
- Allgemeine Geometrie, sehr gute Spankontrolle
- All-round insert with efficient chip control

PN

PR

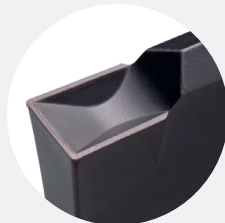

- Géométrie légèrement positive pour les aciers, aciers au carbone, aciers alliés
- Leicht positive Geometrie für Stahl, Kohlenstoffstahl, legiertem Stahl
- Slightly positive geometry for steel, carbon steel, alloyed steel

TN



- Géométrie négative pour de fortes avances dans des conditions de rigidité favorable
- Negative Geometrie für hohe Vorschübe in guten Stabilitätsfällen
- Negative geometry for high feed rate in case of good stability

GN







- Géométrie universelle pour foncer-tourner. Peut également être utilisée en tronçonnage
- Allgemeine Geometrie zum einsteckenlangdrehen. Kann auch zum abstechen verwendet werden
- All-round insert for grooving and turning. Can also be used for parting off

# CUT-Line

Paramètres de coupe indicatifs

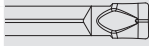
Empfohlene Schnittwerte

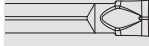
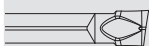
Standard machining data

			<span style="border: 1px solid black; padding: 2px;">P</span> Acier Stahl Steel						<span style="border: 1px solid black; padding: 2px;">M</span> Inox Rostfreistahl Stainless steel	
			Acier de décolletage Automatenstahl Free-cutting steel		Acier faiblement allié Leicht legierter Stahl Low alloyed steel		Acier fortement allié Legierter Stahl High alloyed steel		Austénitique et martensitique Austenitisch und martensitisch Austenitic and martensitic	
			VC (m/min)	F (mm/U)	VC (m/min)	F (mm/U)	VC (m/min)	F (mm/U)	VC (m/min)	F (mm/U)
Avance standard Standard Vorschub Standard feed rate	CUT16-UN-001 	TiALN	90-140	0.03-0.07	60-120	0.03-0.07	50-100	0.04-0.08	50-120	0.03-0.07
		Tmax	100-170	0.03-0.07	70-150	0.03-0.07	60-120	0.04-0.08	60-150	0.03-0.07
		HTA	70-120	0.03-0.05	60-100	0.03-0.05	50-90	0.03-0.05	50-100	0.03-0.06
		AS								
	CUT16-PR-801 	TiALN	90-140	0.03-0.07	60-120	0.03-0.07	50-100	0.03-0.07	50-120	0.03-0.07
		Tmax	100-170	0.03-0.07	70-150	0.03-0.07	60-120	0.03-0.07	60-150	0.03-0.07
Avance modérée Niedriger Vorschub Low feed rate	CUT16-UN-000 	TiALN	80-130	0.02-0.05	50-110	0.02-0.05	50-90	0.02-0.05	50-80	0.02-0.05
		HTA	60-100	0.01-0.04	50-90	0.01-0.04	50-80	0.02-0.05	50-80	0.02-0.05
		AS								
	CUT16-UL/R-800 	TiALN	80-130	0.02-0.05	50-110	0.02-0.05	50-90	0.02-0.05	50-80	0.02-0.05
		HTA	60-100	0.01-0.04	50-90	0.01-0.04	50-80	0.02-0.05	50-80	0.02-0.05
		AS								
	CUT16-UL/R-1500 	TiALN	80-130	0.02-0.05	50-110	0.02-0.05	50-90	0.02-0.05	50-80	0.02-0.05
		HTA	60-100	0.01-0.04	50-90	0.01-0.04	50-80	0.02-0.05	50-80	0.02-0.05
		AS								

\*\* arête de coupe vive

\*\* scharfe Schneidkante

\*\* sharp cutting edge

<span style="border: 1px solid black; border-radius: 50%; padding: 2px;">N</span> Alliages d'aluminium et non ferreux Aluminium- und Nichteisenlegierungen Aluminium and non-ferrous alloys								<span style="border: 1px solid black; border-radius: 50%; padding: 2px;">S</span> Titane Titan Titanium			
Aluminium		Alu silicium max. 5% Aluminiumsilicium max. 5% Aluminium silicon max. 5%		Cuivre Kupfer Copper		Laiton & bronze Messing & Bronze Brass & bronze		Gr. 1 - 3		Gr. 4 - 5	
VC (m/min)	F (mm/U)	VC (m/min)	F (mm/U)	VC (m/min)	F (mm/U)	VC (m/min)	F (mm/U)	VC (m/min)	F (mm/U)	VC (m/min)	F (mm/U)
100-250	0.03-0.10	100-250	0.03-0.10	100-300	0.03-0.10	100-300	0.03-0.10			30-60	0.04-0.08
100-300	0.04-0.10	100-250	0.04-0.10	100-300	0.03-0.08	150-300	0.03-0.08			30-60	0.04-0.08
150-300	0.04-0.15	100-300	0.04-0.10	100-300	0.04-0.10	150-300	0.02-0.08	30-60	0.04-0.08	30-60	0.04-0.08
						150-300	0.03-0.10				
100-300	0.02-0.05	100-250	0.01-0.04	100-250	0.01-0.04	100-300	0.02-0.05			30-60	0.01-0.04
100-300	0.02-0.05	100-250	0.02-0.05	100-250	0.02-0.05	100-300	0.02-0.05			30-60	0.02-0.06
100-300	0.02-0.05	100-250	0.02-0.05	100-250	0.02-0.05	100-300	0.02-0.05	30-60	0.02-0.06	30-60	0.02-0.06
100-300	0.02-0.05	100-250	0.01-0.04	100-250	0.01-0.04	100-300	0.02-0.05			30-60	0.01-0.04
100-300	0.02-0.05	100-250	0.02-0.05	100-250	0.02-0.05	100-300	0.02-0.05			30-60	0.02-0.06
100-300	0.02-0.05	100-250	0.02-0.05	100-250	0.02-0.05	100-300	0.02-0.05	30-60	0.02-0.06	30-60	0.02-0.06
100-300	0.02-0.05	100-250	0.01-0.04	100-250	0.01-0.04	100-300	0.02-0.05			30-60	0.01-0.04
100-300	0.02-0.05	100-250	0.02-0.05	100-250	0.02-0.05	100-300	0.02-0.05			30-60	0.02-0.06
100-300	0.02-0.05	100-250	0.02-0.05	100-250	0.02-0.05	100-300	0.02-0.05	30-60	0.02-0.06	30-60	0.02-0.06

★★★★★

★★★★







★★★

# CUT-Line

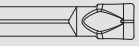
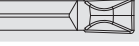
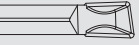
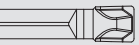
Paramètres de coupe indicatifs

Empfohlene Schnittwerte

Standard machining data

			P Acier Stahl Steel						M Inox Rostfreistahl Stainless steel	
			Acier de décolletage Automatenstahl Free-cutting steel		Acier faiblement allié Leicht legierter Stahl Low alloyed steel		Acier fortement allié Legierter Stahl High alloyed steel		Austénitique et martensitique Austenitisch und martensitisch Austenitic and martensitic	
			VC (m/min)	F (mm/U)	VC (m/min)	F (mm/U)	VC (m/min)	F (mm/U)	VC (m/min)	F (mm/U)
Avance standard Standard Vorschub Standard feed rate	CUT22-UN-002 	TiALN	90-140	0.04-0.08	60-120	0.04-0.08	50-100	0.04-0.08	50-120	0.04-0.08
		Tmax	100-170	0.04-0.08	70-150	0.04-0.08	60-120	0.04-0.08	60-150	0.04-0.08
		Zmax	80-130*	0.04-0.10	50-110*	0.04-0.10	50-90*	0.04-0.08	50-120*	0.04-0.10
		HTA	70-120	0.04-0.06	60-100	0.04-0.06	50-90	0.04-0.06	50-100	0.04-0.06
		AS								
	CUT22-PN-002 	TiALN	90-140	0.04-0.10	60-120	0.04-0.08	50-100	0.04-0.08		
		Tmax	100-170	0.04-0.10	70-150	0.04-0.10	60-120	0.04-0.10		
	CUT22-PR-002 	TiALN	90-140	0.04-0.08	60-120	0.04-0.08	50-100	0.04-0.08	50-120	0.04-0.08
		Tmax	100-170	0.04-0.08	70-150	0.04-0.08	60-120	0.04-0.08	60-150	0.04-0.08
	CUT22-TN-002 	TiALN	90-140	0.08-0.18	60-120	0.08-0.18	50-100	0.08-0.15	50-120	0.08-0.20
		Tmax	100-170	0.08-0.18	70-150	0.08-0.18	60-120	0.08-0.15	60-150	0.08-0.20
		Zmax	80-130*	0.08-0.18	50-110*	0.08-0.18	50-90*	0.08-0.15		
	CUT22-GN-002 *** 	TiALN	90-140	0.03-0.12	60-120	0.03-0.12	50-100	0.03-0.10	50-120	0.03-0.08
		Tmax	100-170	0.03-0.12	70-150	0.03-0.12	60-120	0.03-0.10	70-120	0.03-0.08
		AS								
Avance modérée Niedriger Vorschub Low feed rate	CUT22-UN-000 	TiALN	80-130	0.02-0.05	50-110	0.02-0.05	50-90	0.02-0.05	50-80	0.02-0.05
		HTA	60-100	0.01-0.04	50-90	0.01-0.04	50-80	0.02-0.05	50-80	0.02-0.05
		AS								
	CUT22-UL/R-800 	TiALN	80-130	0.02-0.05	50-110	0.02-0.05	50-90	0.02-0.05	50-80	0.02-0.05
		HTA	60-100	0.01-0.04	50-90	0.01-0.04	50-80	0.02-0.05	50-80	0.02-0.05
		AS								
	CUT22-UL/R-802 	TiALN	80-130	0.02-0.05	50-110	0.02-0.05	50-90	0.02-0.05	50-80	0.02-0.05
		HTA	60-100	0.01-0.04	50-90	0.01-0.04	50-80	0.02-0.05	50-80	0.02-0.05
		AS								
	CUT22-UL/R-1500 	TiALN	80-130	0.02-0.05	50-110	0.02-0.05	50-90	0.02-0.05	50-80	0.02-0.05
		HTA	60-100	0.01-0.04	50-90	0.01-0.04	50-80	0.02-0.05	50-80	0.02-0.05
		AS								

\* premier choix en cas de coupe interrompue

\*\* arête de coupe vive

\*\*\* géométrie fonçage-tournage (évent. tronçonnage)

\* beste Basis für unterbrochene Schnitte

\*\* scharfe Schneidkante

\*\*\* Geometrie zum einstechen und drehen (event. abstechen)

\* first choice for interrupted cut

\*\* sharp cutting edge

\*\*\* geometry for grooving and turning (event. parting off)



<span style="border: 1px solid black; border-radius: 50%; padding: 2px;">N</span> Alliages d'aluminium et non ferreux Aluminium- und Nichteisenlegierungen Aluminium and non-ferrous alloys								<span style="border: 1px solid black; border-radius: 50%; padding: 2px;">S</span> Titane Titan Titanium			
Aluminium		Alu silicium max. 5% Aluminiumsilicium max. 5% Aluminium silicon max. 5%		Cuivre Kupfer Copper		Laiton & bronze Messing & Bronze Brass & bronze		Gr. 1 - 3		Gr. 4 - 5	
VC (m/min)	F (mm/U)	VC (m/min)	F (mm/U)	VC (m/min)	F (mm/U)	VC (m/min)	F (mm/U)	VC (m/min)	F (mm/U)	VC (m/min)	F (mm/U)
100-250	0.03-0.10	100-250	0.03-0.10	100-300	0.03-0.10	100-300	0.03-0.10			30-60	0.04-0.08
100-300	0.04-0.10	100-250	0.04-0.10	100-300	0.03-0.08	150-300	0.03-0.08			30-60	0.04-0.08
150-300	0.04-0.15	100-300	0.04-0.10	100-300	0.04-0.10	150-300	0.02-0.08	30-60	0.04-0.08	30-60	0.04-0.08
						150-300	0.03-0.10				
						150-300	0.03-0.10				
						150-300	0.05-0.2				
100-300	0.03-0.12	100-200	0.03-0.10	100-200	0.03-0.10	100-300	0.03-0.12			30-60	0.04-0.08
						100-300	0.03-0.12				
100-300	0.03-0.12	100-200	0.03-0.10	100-200	0.03-0.10	100-300	0.03-0.12	30-60	0.04-0.08	30-60	0.04-0.08
100-300	0.02-0.05	100-250	0.01-0.04	100-250	0.01-0.04	100-300	0.02-0.05			30-60	0.01-0.04
100-300	0.02-0.05	100-250	0.02-0.05	100-250	0.02-0.05	100-300	0.02-0.05			30-60	0.02-0.06
100-300	0.02-0.05	100-250	0.02-0.05	100-250	0.02-0.05	100-300	0.02-0.05	30-60	0.02-0.06	30-60	0.02-0.06
100-300	0.02-0.05	100-250	0.01-0.04	100-250	0.01-0.04	100-300	0.02-0.05			30-60	0.01-0.04
100-300	0.02-0.05	100-250	0.02-0.05	100-250	0.02-0.05	100-300	0.02-0.05			30-60	0.02-0.06
100-300	0.02-0.05	100-250	0.02-0.05	100-250	0.02-0.05	100-300	0.02-0.05	30-60	0.02-0.06	30-60	0.02-0.06
100-300	0.02-0.05	100-250	0.01-0.04	100-250	0.01-0.04	100-300	0.02-0.05			30-60	0.01-0.04
100-300	0.02-0.05	100-250	0.02-0.05	100-250	0.02-0.05	100-300	0.02-0.05			30-60	0.02-0.06
100-300	0.02-0.05	100-250	0.02-0.05	100-250	0.02-0.05	100-300	0.02-0.05	30-60	0.02-0.06	30-60	0.02-0.06
100-300	0.02-0.05	100-250	0.01-0.04	100-250	0.01-0.04	100-300	0.02-0.05			30-60	0.01-0.04
100-300	0.02-0.05	100-250	0.02-0.05	100-250	0.02-0.05	100-300	0.02-0.05			30-60	0.02-0.06
100-300	0.02-0.05	100-250	0.02-0.05	100-250	0.02-0.05	100-300	0.02-0.05	30-60	0.02-0.06	30-60	0.02-0.06







# CUT-Line

Paramètres de coupe indicatifs

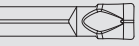
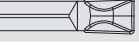
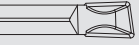
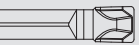
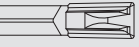
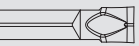
Empfohlene Schnittwerte

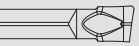
Standard machining data

			P Acier Stahl Steel						M Inox Rostfreistahl Stainless steel	
			Acier de décolletage Automatenstahl Free-cutting steel		Acier faiblement allié Leicht legierter Stahl Low alloyed steel		Acier fortement allié Legierter Stahl High alloyed steel		Austénitique et martensitique Austenitisch und martensitisch Austenitic and martensitic	
			VC (m/min)	F (mm/U)	VC (m/min)	F (mm/U)	VC (m/min)	F (mm/U)	VC (m/min)	F (mm/U)
Avance standard Standard Vorschub Standard feed rate	CUT31-UN-002 	TiALN	90-140	0.04-0.08	60-120	0.04-0.08	50-100	0.04-0.08	50-120	0.04-0.10
		Tmax	100-170	0.04-0.08	70-150	0.04-0.08	60-120	0.04-0.08	60-150	0.04-0.10
		Zmax	80-130*	0.04-0.10	50-110*	0.04-0.10	50-90*	0.04-0.08	50-120*	0.04-0.10
		HTA	70-120	0.04-0.06	60-100	0.04-0.06	50-90	0.04-0.06	50-100	0.04-0.06
		AS								
	CUT31-PN-002 	TiALN	90-140	0.04-0.10	60-120	0.04-0.08	50-100	0.04-0.08		
		Tmax	100-170	0.04-0.10	70-150	0.04-0.10	60-120	0.04-0.10		
	CUT31-PR-002 	TiALN	90-140	0.04-0.08	60-120	0.04-0.08	50-100	0.04-0.08	50-120	0.04-0.08
		Tmax	100-170	0.04-0.08	70-150	0.04-0.08	60-120	0.04-0.08	60-150	0.04-0.08
	CUT31-TN-002 	TiALN	90-140	0.08-0.20	60-120	0.08-0.20	50-100	0.08-0.15	50-120	0.08-0.20
		Tmax	100-170	0.08-0.20	70-150	0.08-0.20	60-120	0.08-0.15	60-150	0.08-0.20
		Zmax	80-130*	0.08-0.20	50-110*	0.08-0.20	50-90*	0.08-0.15		
	CUT31-GN-002 *** 	TiALN	90-140	0.04-0.15	60-120	0.04-0.15	50-100	0.04-0.10	50-120	0.04-0.10
		Tmax	100-170	0.04-0.15	70-150	0.04-0.15	60-120	0.04-0.10	70-120	0.04-0.10
		AS								
Avance modérée Niedriger Vorschub Low feed rate	CUT31-UN-000 	TiALN	80-130	0.02-0.05	50-110	0.02-0.05	50-90	0.02-0.05	50-80	0.02-0.05
		HTA	60-100	0.01-0.04	50-90	0.01-0.04	50-80	0.02-0.05	50-80	0.02-0.05
		AS								
	CUT31-UL/R-800 	TiALN	80-130	0.02-0.05	50-110	0.02-0.05	50-90	0.02-0.05	50-80	0.02-0.05
		HTA	60-100	0.01-0.04	50-90	0.01-0.04	50-80	0.02-0.05	50-80	0.02-0.05
		AS								
	CUT31-UL/R-802 	TiALN	80-130	0.02-0.05	50-110	0.02-0.05	50-90	0.02-0.05	50-80	0.02-0.05
		HTA	60-100	0.01-0.04	50-90	0.01-0.04	50-80	0.02-0.05	50-80	0.02-0.05
		AS								
	CUT31-UL/R-1500 	TiALN	80-130	0.02-0.05	50-110	0.02-0.05	50-90	0.02-0.05	50-80	0.02-0.05
		HTA	60-100	0.01-0.04	50-90	0.01-0.04	50-80	0.02-0.05	50-80	0.02-0.05
		AS								

\* premier choix en cas de coupe interrompue

\*\* arête de coupe vive

\*\*\* géométrie fonçage-tournage (évent. tronçonnage)

\* beste Basis für unterbrochene Schnitte

\*\* scharfe Schneidkante

\*\*\* Geometrie zum einstechen und drehen (event. abstechen)

\* first choice for interrupted cut

\*\* sharp cutting edge

\*\*\* geometry for grooving and turning (event. parting off)

<span style="border: 1px solid black; padding: 2px;">N</span> Alliages d'aluminium et non ferreux Aluminium- und Nichteisenlegierungen Aluminium and non-ferrous alloys								<span style="border: 1px solid black; padding: 2px;">S</span> Titane Titan Titanium			
Aluminium		Alu silicium max. 5% Aluminiumsilicium max. 5% Aluminium silicon max. 5%		Cuivre Kupfer Copper		Laiton & bronze Messing & Bronze Brass & bronze		Gr. 1 - 3		Gr. 4 - 5	
VC (m/min)	F (mm/U)	VC (m/min)	F (mm/U)	VC (m/min)	F (mm/U)	VC (m/min)	F (mm/U)	VC (m/min)	F (mm/U)	VC (m/min)	F (mm/U)
100-250	0.03-0.10	100-250	0.03-0.10	100-300	0.03-0.10	100-300	0.03-0.10			30-60	0.04-0.08
100-300	0.04-0.10	100-250	0.04-0.10	100-300	0.03-0.08	150-300	0.03-0.08			30-60	0.04-0.08
150-300	0.04-0.15	100-300	0.04-0.10	100-300	0.04-0.10	150-300	0.02-0.08	30-60	0.04-0.08	30-60	0.04-0.08
						150-300	0.03-0.10				
						150-300	0.03-0.10				
						150-300	0.05-0.20				
100-300	0.04-0.15	100-200	0.04-0.10	100-200	0.04-0.10	100-300	0.04-0.15			30-60	0.04-0.08
						100-300	0.04-0.15				
100-300	0.04-0.15	100-200	0.04-0.10	100-200	0.04-0.10	100-300	0.04-0.15	30-60	0.04-0.08	30-60	0.04-0.08
100-300	0.02-0.05	100-250	0.01-0.04	100-250	0.01-0.04	100-300	0.02-0.05			30-60	0.01-0.04
100-300	0.02-0.05	100-250	0.02-0.05	100-250	0.02-0.05	100-300	0.02-0.05			30-60	0.02-0.06
100-300	0.02-0.05	100-250	0.02-0.05	100-250	0.02-0.05	100-300	0.02-0.05	30-60	0.02-0.06	30-60	0.02-0.06
100-300	0.02-0.05	100-250	0.01-0.04	100-250	0.01-0.04	100-300	0.02-0.05			30-60	0.01-0.04
100-300	0.02-0.05	100-250	0.02-0.05	100-250	0.02-0.05	100-300	0.02-0.05			30-60	0.02-0.06
100-300	0.02-0.05	100-250	0.02-0.05	100-250	0.02-0.05	100-300	0.02-0.05	30-60	0.02-0.06	30-60	0.02-0.06
100-300	0.02-0.05	100-250	0.01-0.04	100-250	0.01-0.04	100-300	0.02-0.05			30-60	0.01-0.04
100-300	0.02-0.05	100-250	0.02-0.05	100-250	0.02-0.05	100-300	0.02-0.05			30-60	0.02-0.06
100-300	0.02-0.05	100-250	0.02-0.05	100-250	0.02-0.05	100-300	0.02-0.05	30-60	0.02-0.06	30-60	0.02-0.06
100-300	0.02-0.05	100-250	0.01-0.04	100-250	0.01-0.04	100-300	0.02-0.05			30-60	0.01-0.04
100-300	0.02-0.05	100-250	0.02-0.05	100-250	0.02-0.05	100-300	0.02-0.05			30-60	0.02-0.06
100-300	0.02-0.05	100-250	0.02-0.05	100-250	0.02-0.05	100-300	0.02-0.05	30-60	0.02-0.06	30-60	0.02-0.06

★★★★★

★★★★

★★★

# CUT-Line

Porte-outils



Halter

Holder

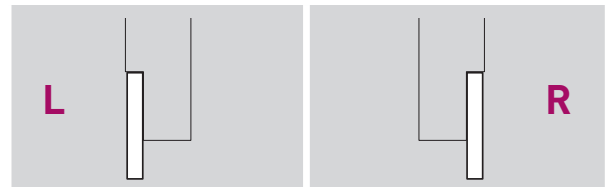
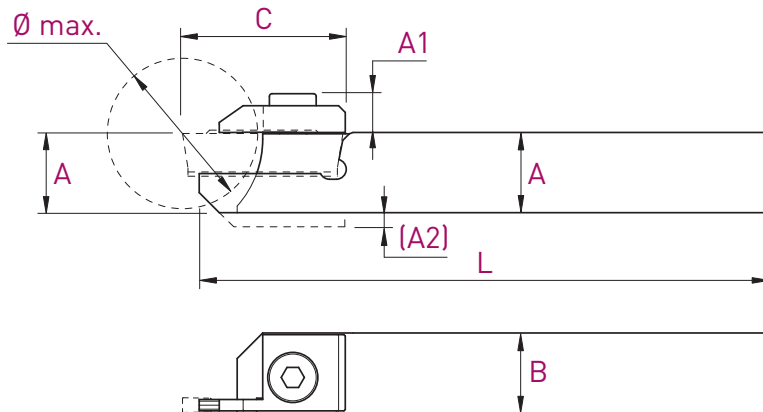
Ø max 34 mm – H Series



Plaquette WSP Insert	A x B x L	Ø max.	A1	C	Art. N°	Art. N°
<b>W</b> 1.6 mm <b>Type</b> CUT16	8 x 10 x 115 (A2=2)	16	6.2	19.5	CUT16-H0810L	CUT16-H0810R
	10 x 10 x 115	16	6.2	19.5	CUT16-H1010L	CUT16-H1010R
	12 x 12 x 130	16	6.2	19.5	CUT16-H1212L	CUT16-H1212R
	12 x 12 x 90	16	6.2	19.5	CUT16-H1212L-90	CUT16-H1212R-90
	12.7 x 12.7 x 130	16	6.2	19.5	CUT16-H127127L	CUT16-H127127R
	16 x 16 x 130	16	6.2	19.5	CUT16-H1616L	CUT16-H1616R
	20 x 20 x 120	16	6.2	19.5	CUT16-H2020L	CUT16-H2020R
<b>W</b> 2.2 mm <b>Type</b> CUT22	10 x 12 x 115	20	6.4	24	CUT22-H1012L	CUT22-H1012R
	12 x 12 x 130	20	6.4	24	CUT22-H1212L	CUT22-H1212R
	12 x 12 x 90	20	6.4	24	CUT22-H1212L-90	CUT22-H1212R-90
	12.7 x 12.7 x 130	20	6.4	24	CUT22-H127127L	CUT22-H127127R
	16 x 16 x 130	20	6.4	24	CUT22-H1616L	CUT22-H1616R
	20 x 20 x 120	20	6.4	24	CUT22-H2020L	CUT22-H2020R
<b>W</b> 3.1 mm <b>Type</b> CUT31	16 x 16 x 130	34	7.8	35	CUT31-H1616L	CUT31-H1616R
	20 x 20 x 120	34	7.8	35	CUT31-H2020L	CUT31-H2020R
	25 x 25 x 140	34	7.8	35	CUT31-H2525L	CUT31-H2525R

Pièces de rechange Ersatzteile Spare parts	L 	R 		Serrage Anzug Torque
	Art. N°	Art. N°	Art. N°	
CUT 16	CUT16L-SET	CUT16R-SET	V-M4x10-BN7	3.5 Nm
CUT 22	CUT22L-SET	CUT22R-SET	V-M4x10-BN7	3.5 Nm
CUT 31	CUT31L-SET	CUT31R-SET	V-M5x10-BN7	4.5 Nm

Porte-outils



Halter

Holder

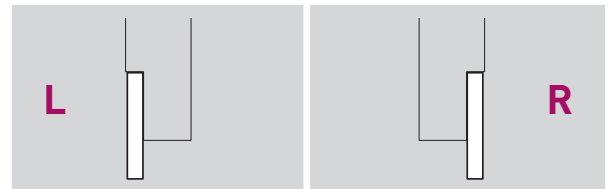
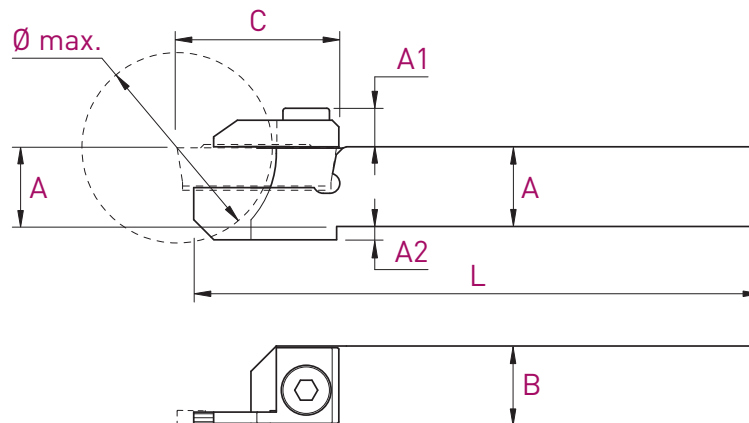
Ø max 42 mm – HX Series

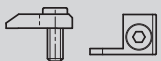

Plaquette WSP Insert	A x B x L	Ø max.	A1	C	A2	Art. N°	Art. N°
<b>W</b> 1.6 mm <b>Type</b> CUT16	10 x 12 x 115	20	6.2	21	2	CUT16-H1012LX	CUT16-H1012RX
	12 x 12 x 130	20	6.2	21	-	CUT16-H1212LX	CUT16-H1212RX
	12 x 12 x 90	20	6.2	21	-	CUT16-H1212LX-90	CUT16-H1212RX-90
	12.7 x 12.7 x 130	20	6.2	21	-	CUT16-H127127LX	CUT16-H127127RX
	16 x 16 x 130	20	6.2	21	-	CUT16-H1616LX	CUT16-H1616RX
	20 x 20 x 120	20	6.2	21	-	CUT16-H2020LX	CUT16-H2020RX
<b>W</b> 2.2 mm <b>Type</b> CUT22	10 x 12 x 115	26	6.4	25	4	CUT22-H1012LX	CUT22-H1012RX
	12 x 12 x 130	26	6.4	25	2	CUT22-H1212LX	CUT22-H1212RX
	12 x 12 x 90	26	6.4	25	2	CUT22-H1212LX-90	CUT22-H1212RX-90
	12.7 x 12.7 x 130	26	6.4	25	-	CUT22-H127127LX	CUT22-H127127RX
	16 x 16 x 130	26	6.4	25	-	CUT22-H1616LX	CUT22-H1616RX
	20 x 20 x 120	26	6.4	25	-	CUT22-H2020LX	CUT22-H2020RX
	25 x 25 x 140	26	6.4	25	-	CUT22-H2525LX	CUT22-H2525RX
<b>W</b> 3.1 mm <b>Type</b> CUT31	16 x 16 x 120	42	7.8	37	4	CUT31-H1616LX	CUT31-H1616RX
	20 x 20 x 120	42	7.8	37	-	CUT31-H2020LX	CUT31-H2020RX
	25 x 25 x 140	42	7.8	37	-	CUT31-H2525LX	CUT31-H2525RX

Pièces de rechange Ersatzteile Spare parts	<b>L</b> 	 <b>R</b>		Serrage Anzug Torque
	Art. N°	Art. N°	Art. N°	
CUT 16	CUT16LX-SET	CUT16RX-SET	V-M4x10-BN7	3.5 Nm
CUT 22	CUT22LX-SET	CUT22RX-SET	V-M4x10-BN7	3.5 Nm
CUT 31	CUT31LX-SET	CUT31RX-SET	V-M5x10-BN7	4.5 Nm

# CUT-Line

Porte-outils

Halter

Holder

Ø max 65 mm – HZ Series

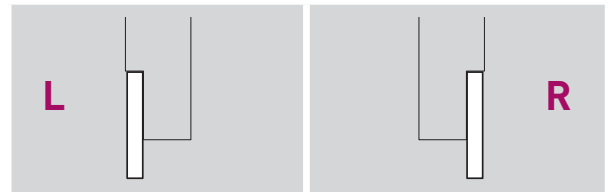
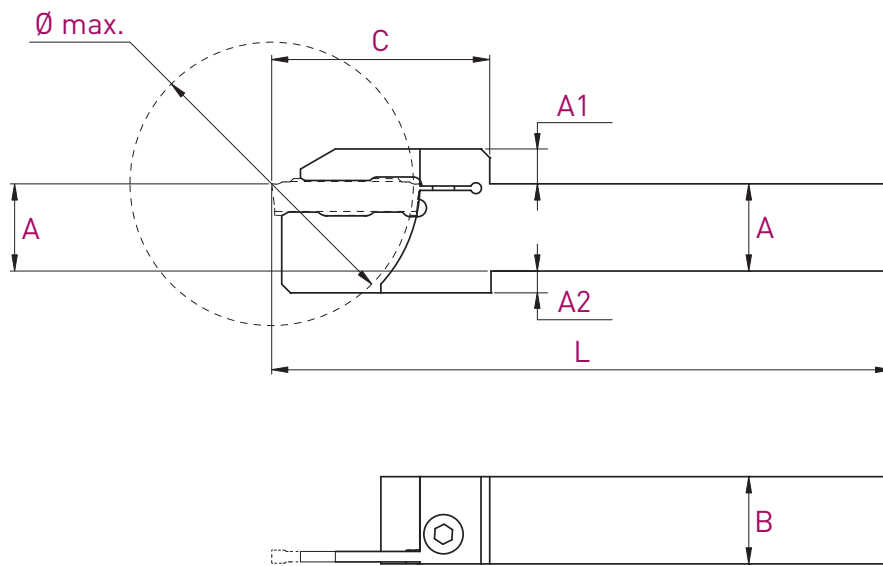

Plaquette WSP Insert	A x B x L	Ø max.	A1	C	A2	Art. N°	Art. N°
<b>W</b> 2.2 mm	16 x 16 x 130	32	7	30	-	CUT22-H1616LZ-D32	CUT22-H1616RZ-D32
	20 x 20 x 130	32	7	30	-	CUT22-H2020LZ-D32	CUT22-H2020RZ-D32
<b>Type</b> CUT22	16 x 16 x 130	42	7	35	4	CUT22-H1616LZ-D42	CUT22-H1616RZ-D42
	20 x 20 x 130	42	7	35	-	CUT22-H2020LZ-D42	CUT22-H2020RZ-D42
<b>W</b> 3.1 mm	20 x 20 x 140	52	8	44	5	CUT31-H2020LZ-D52	CUT31-H2020RZ-D52
	25 x 25 x 140	52	8	44	-	CUT31-H2525LZ-D52	CUT31-H2525RZ-D52
<b>Type</b> CUT31	20 x 20 x 140	65	8	50	5	CUT31-H2020LZ-D65	CUT31-H2020RZ-D65
	25 x 25 x 140	65	8	50	-	CUT31-H2525LZ-D65	CUT31-H2525RZ-D65

Pièces de rechange Ersatzteile Spare parts		Serrage Anzug Torque
	Art. N°	
CUT 22	V-M4x10-BN7	3.5 Nm
CUT 31	V-M5x10-BN7	4.5 Nm

Porte-outils avec arrosage intégré

Halter mit integriertem Kühlmittelzufuhr

Holder with integrated coolant supply

## HZ-JET Series

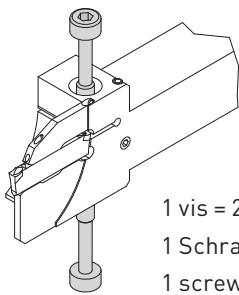
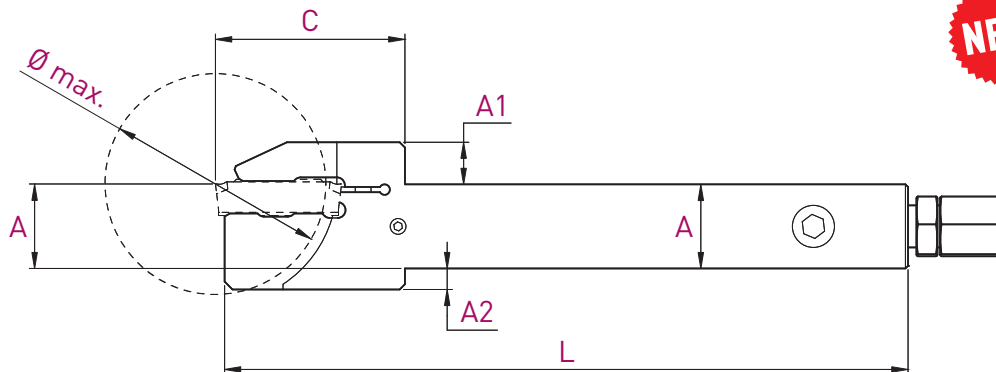

1 vis = 2 possibilités de serrage  
 1 Schraube = 2 Spannmöglichkeiten  
 1 screw = 2 clamp possibilities

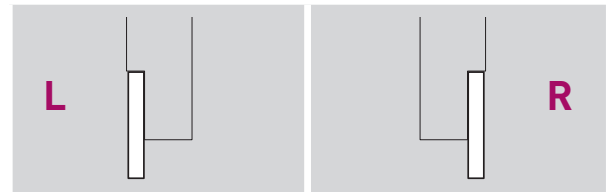
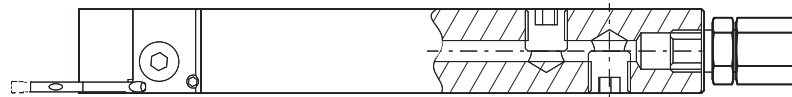

Plaquette WSP Insert	A x B x L	Ø max.	A1	C	A2	Art. N°	Art. N°
<b>Type</b> CUT22	16 x 16 x 130	42	8	36	4	CUT22-H1616LZ-JET42	CUT22-H1616RZ-JET42
	20 x 20 x 130	42	8	36	-	CUT22-H2020LZ-JET42	CUT22-H2020RZ-JET42
<b>Type</b> CUT31	20 x 20 x 140	65	9	51	5	CUT31-H2020LZ-JET65	CUT31-H2020RZ-JET65
	25 x 25 x 140	65	9	51	-	CUT31-H2525LZ-JET65	CUT31-H2525RZ-JET65

Pièces de rechange Ersatzteile Spare parts		Serrage Anzug Torque		
	Art. N°		Art. N°	Art. N°
CUT 22	V-M4x22-CUT	3.5 Nm	C-M8x1-D6	CB-M8x1
CUT 31	V-M5x25-CUT	4.5 Nm	C-M8x1-D6	CB-M8x1

# CUT-Line

Plaquettes de tronçonnage

Abstechwendeplatten

Cut off inserts

UN Series

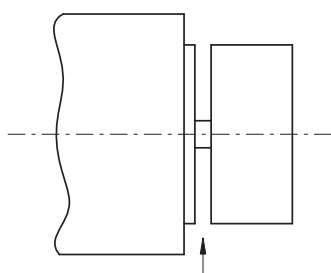
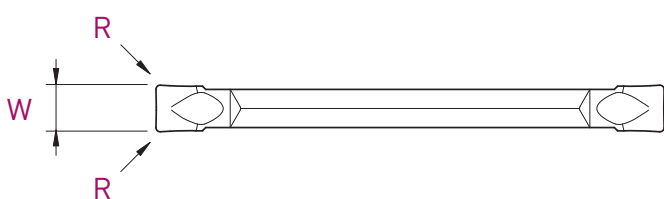
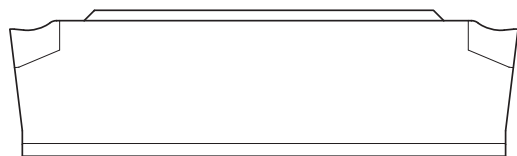

UN



Type	W $\pm 0,05$	R	Art. N°	TIALN	Tmax	Zmax	HTA	AS
CUT16	1.6	0.02	CUT16-UN-000	■			■	■
	1.6	0.10	CUT16-UN-001	■	■		■	■
CUT22	2.2	0.02	CUT22-UN-000	■			■	■
	2.2	0.20	CUT22-UN-002	■	■	■	■	■
CUT31	3.1	0.02	CUT31-UN-000	■			■	■
	3.1	0.20	CUT31-UN-002	■	■	■	■	■



Plaquettes de tronçonnage

Abstechwendeplatten

Cut off inserts

## UL-UR Series

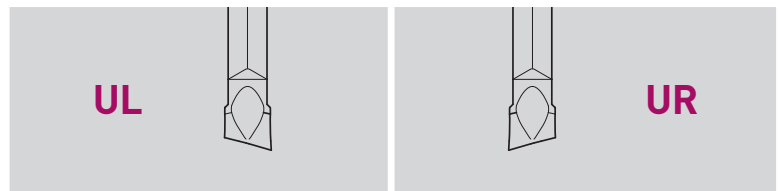
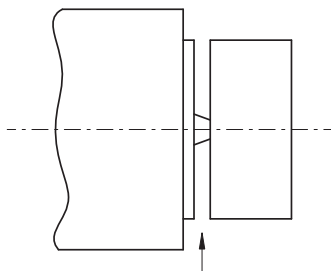
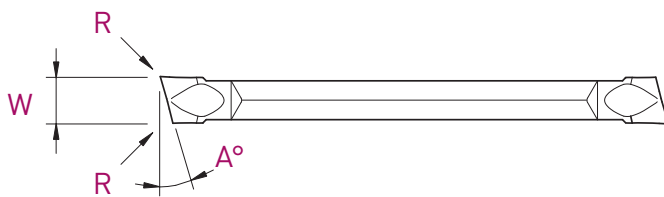
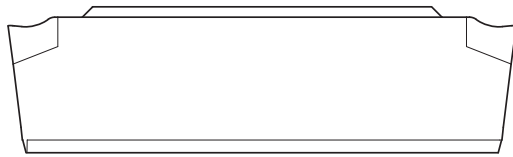

Type	W ±0,05	A	R	UL			UR				
				Art. N°	TiALN	HTA	AS	Art. N°	TiALN	HTA	AS
CUT16	1.6	8°	0.02	CUT16-UL-800	■	■	■	CUT16-UR-800	■	■	■
	1.6	15°	0.02	CUT16-UL-1500	■	■	■	CUT16-UR-1500	■	■	■
CUT22	2.2	8°	0.02	CUT22-UL-800	■	■	■	CUT22-UR-800	■	■	■
	2.2	8°	0.20	CUT22-UL-802	■	■	■	CUT22-UR-802	■	■	■
	2.2	15°	0.02	CUT22-UL-1500	■	■	■	CUT22-UR-1500	■	■	■
CUT31	3.1	8°	0.02	CUT31-UL-800	■	■	■	CUT31-UR-800	■	■	■
	3.1	8°	0.20	CUT31-UL-802	■	■	■	CUT31-UR-802	■	■	■
	3.1	15°	0.02	CUT31-UL-1500	■	■	■	CUT31-UR-1500	■	■	■

# CUT-Line

Plaquettes de tronçonnage

Abstechwendeplatten

Cut off inserts

PN Series

**NEW**

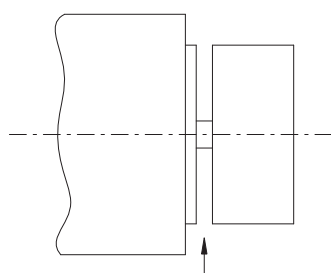
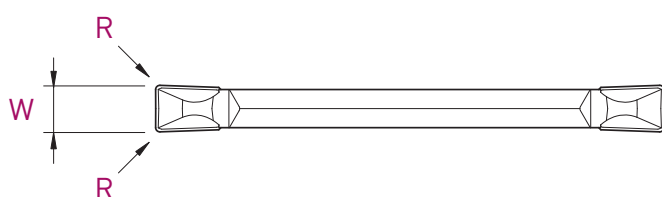
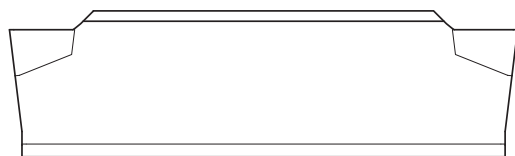

PN



Type	W $\pm 0.05$	R	Art. N°	TiALN	Tmax
CUT22	2.2	0.20	CUT22-PN-002	■	■
CUT31	3.1	0.20	CUT31-PN-002	■	■

Plaquettes de tronçonnage

Abstechwendeplatten

Cut off inserts

PR Series

**NEW**

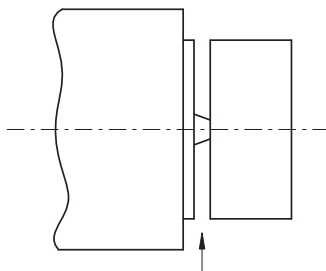
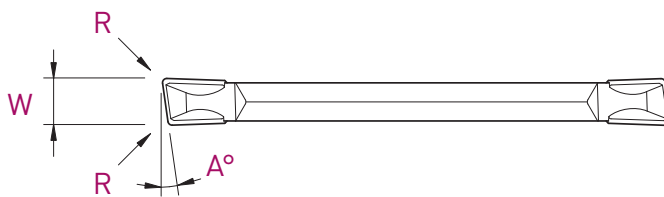
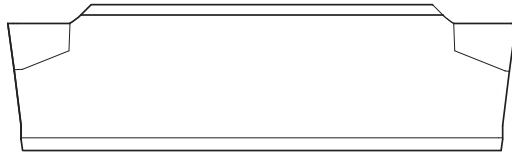

PR

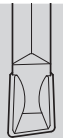

Type	W $\pm 0.05$	A	R	Art. N°	TiAlN	Tmax
CUT16	1.6	8°	0.10	CUT16-PR-801	■	■
CUT22	2.2	8°	0.20	CUT22-PR-802	■	■
CUT31	3.1	8°	0.20	CUT31-PR-802	■	■

# CUT-Line

Plaquettes de tronçonnage

VHM-Abstechwendeplatten

Solid carbide cut off inserts

TN Series

## Negative cut off

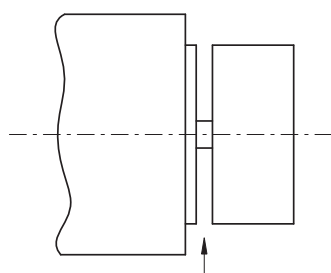
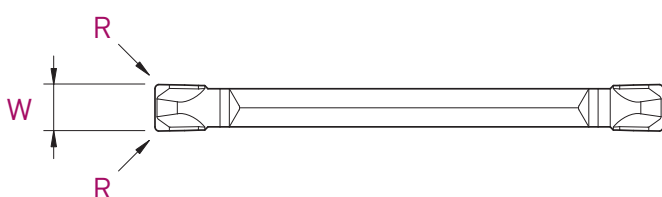
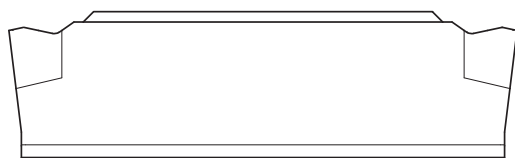

TN



Type	W $\pm 0,05$	R	Art. N°	TiALN	Tmax	Zmax
CUT22	2.2	0.20	CUT22-TN-002	■	■	■
CUT31	3.1	0.20	CUT31-TN-002	■	■	■

Plaquettes de fonçage, tournage et tronçonnage

WSP zum einstecken, drehen und abstechen

Solid carbide inserts for grooving, turning and cut off

## GN Series

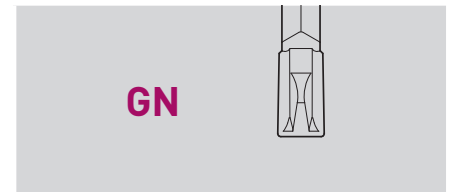
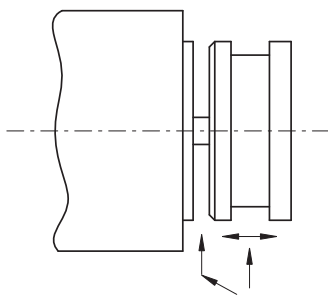
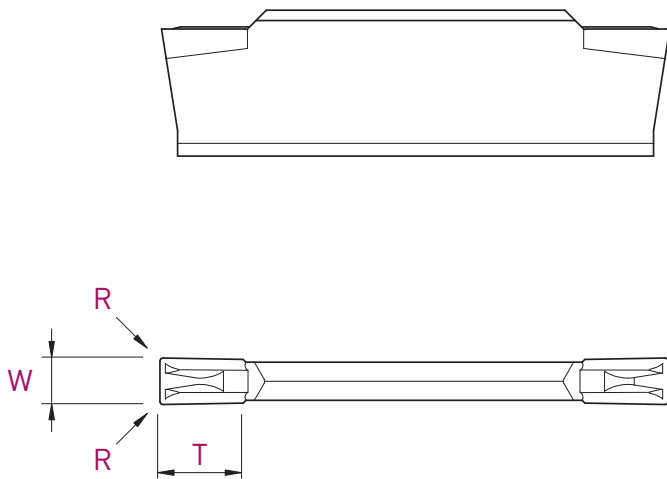

Type	$W_{\pm 0,05}$	T	R	Art. N°	TiAlN	Tmax	AS
CUT22	2.2	3.5	0.15	CUT22-GN-002	■	■	■
CUT31	3.1	5.0	0.15	CUT31-GN-002	■	■	■

Conseils d'utilisation pour plaquettes type GN

Anwendungsempfehlungen für GN-Wendeleplatten

Application recommendations for GN inserts

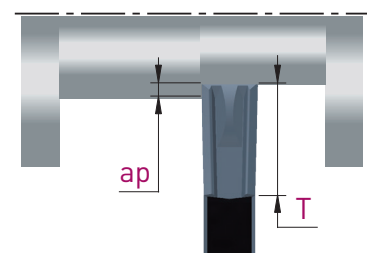
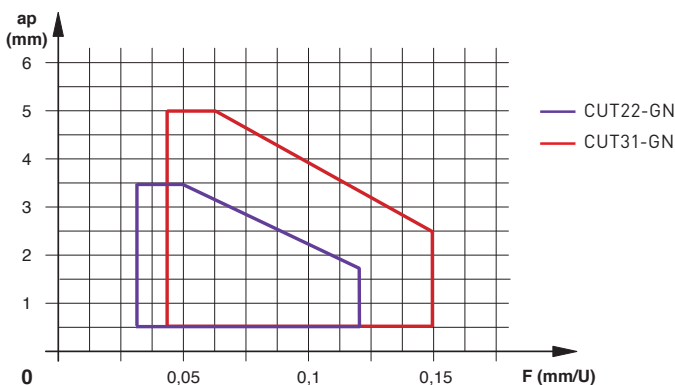

$ap_{max} = T$  dans matière à bonne usinabilité  
 $ap_{max} = T$  in Werkstoffe mit gute Zerspanbarkeit  
 $ap_{max} = T$  in material with good machinability

# ISO-Line

Une gamme complète d'outils ISO pour les tours automatiques  
Ein vollständiges Angebot von ISO Werkzeugen für Drehautomaten  
A complete range of ISO tools dedicated to the automatic lathes



# CIRCO-Line

Une gamme de fraises circulaires carbure monobloc et de tasseaux  
VHM-Kreissägen und Fräsdorne  
Range of carbide saws and arbors



PERFORMANCE | PRECISION | RIGIDITY



SWISS MADE



**APPLITEC**  
SWISS TOOLING

**Applitec Moutier S.A.**  
Ch. Nicolas-Junker 2  
CH-2740 Moutier

Tél. +41 32 494 60 20  
Fax +41 32 493 42 60  
[www.applitec-tools.com](http://www.applitec-tools.com)