



Label	Actual	Deviation
A01	92.15	2.15
D01	12.0102	0.0102
D02	7.9894	-0.0106
L000	119.8736	0.0011
L001	93.8759	0.0003
L002	31.8956	-0.0001

Results are ready.

SCAN MACHINES

The ultimate measurement solution for cylindrical parts



Easy to use



Super fast

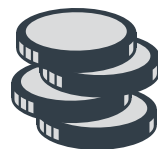

Very quick ROI

General features

APPLICATIONS

Our range of SYLVAC machines are designed to measure round parts with diameters up to 145 mm and up to 1'800 mm long. Most cylindrical parts, such as aerospace and automotive shafts and components, connectors, bone screws and dental implants, hydraulic parts, metal packaging for food and cosmetics, rollers, turbines parts, CNC turned parts, etc. can be measured in a few seconds. Various thread types and features can be measured and analyzed with our machines.



Workpiece Shadow image

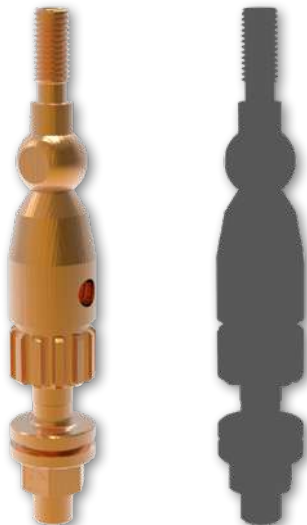

The contour of the workpiece is reproduced on the software and all the various elements shown can be measured in static (without part rotation) or in dynamic (with part rotation) when geometrical features such as run-out or concentricity must be measured.

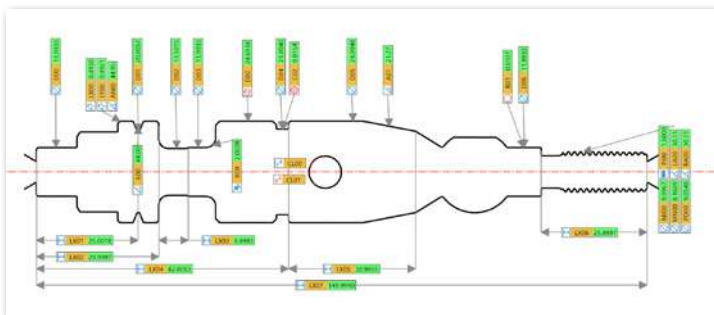

MEASURING PRINCIPLE

All Sylvac-Scan machines incorporate high resolution line-scan cameras. Using the green LED illuminator to project a collimated beam of light across the part, the part is scanned at speeds up to 160mm/s, whilst the contour of the part is collected through the high precision bi-telecentric lens system and the projected image is detected and processed using the latest line-scan camera technology.

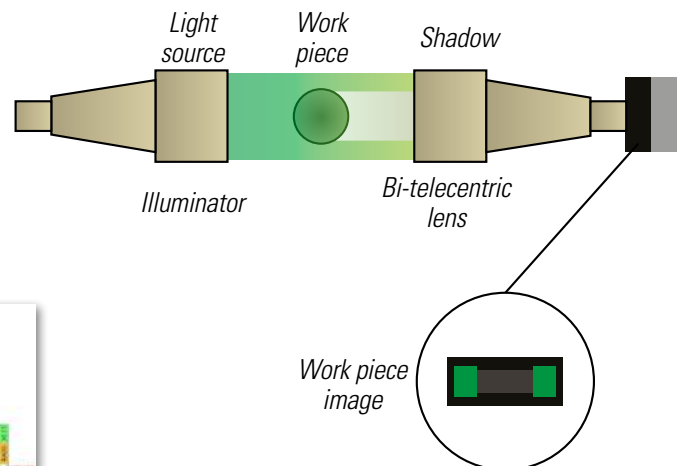











Increase efficiency



One click measurement

-  Reduce inspection time
-  Reduce scrap
-  Increase productivity

-  Easy to use
-  Save money
-  Quick ROI

-  Increase efficiency
-  Reduce CNC downtime
-  Avoid QC bottle necks

Optical machines

SYLVAC SCAN

Optical machine specially designed for workshop measurement close to the machine-tool.

Suitable for first-off part, control in process (SPC), sampling or 100% inspection, our Sylvac SCAN machines are set to revolutionize the control in workshop.

SHOP HARDENED

Sylvac SCAN machines are Swiss made, quality, robust, precision measuring machines designed to work in even the harshest workshop environments. Our machines come with built in calibration masters which are used to keep the machines accuracy and performance within the required specification, compensating for temperature variations.

The S25/S65/S145 ranges, comes with the added value of temperature sensors, used to detect temperature variation and trigger an automatic calibration, which only takes a short moment. Ensuring the highest precision at all times.





CALIBRATION
MASTER



ONE CLICK
MEASUREMENT



REFLEX-CLICK :
THE MEASURING SYSTEM THAT MAKES
EVERYONE AN EXPERT !

Operating principle

SYLVAC-REFLEX SCAN

The SYLVAC-SCAN's are equipped with Reflex SCAN software. These make them robust and easy to use, allowing perfect integration in workshops. Adjacent to operators, it advantageously replaces conventional measuring systems including multi-gauging thanks to unsurpassed flexibility and time saving.



«Reflex-Click technology» for one-click measurement !

The cutting edge REFLEX-Click mode measures your parts with a simple click.

PROGRAMMING MADE EASY

1

Place part



2

Push the start button



3

Part profile is scanned in just a few seconds



4

Main features automatically measured. Edit and save program for repeat work.

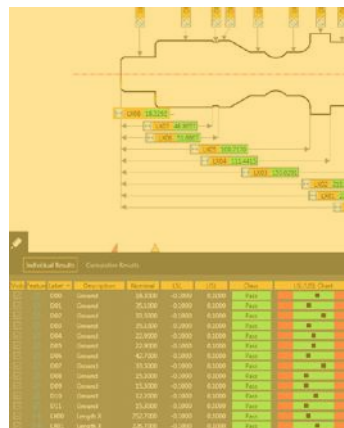

These four operations only take a few minutes.

MEASUREMENT MADE EASY

Step 1: load the part, Step 2: push the button!

The part will be automatically recognised and measured by the machine, displaying classified results in just a few seconds.

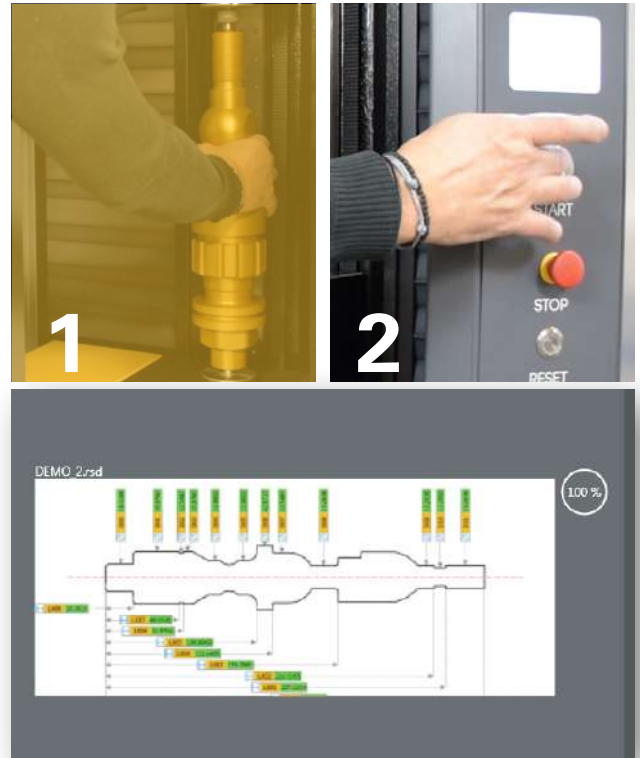

Intelligent automatic part recognition



BARCODE READER

Optionally a barcode reader can be used to instantly recall part programs.

FLEXIBLE REPORT EDITOR

A flexible report editor is also available, enabling you to customize the presentation of your measuring reports by adding information through a drag & drop method.

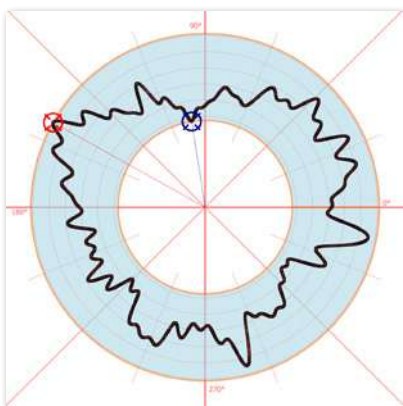

MEASUREMENT ANALYSIS

Once the part is scanned and measured, it is possible to review the scanned data in the measurement analysis window. Allowing the operator to make a visual check of the part in precise detail, whether it is a root radius on a thread or a form measurement of a diameter.

DATA EXPORT AND STATISTICS

The main statistical calculations are included as a standard feature in our RS+ software, along with a statistical view.

Results data can be exported in a variety of formats such as CSV, XML for the purpose of archiving and traceability. Or can be exported as specific formats directly into 3rd party SPC software.

Optionally you can take advantage of the Data Monitoring included with RS+ 'PRO' level software, facilitating live and historical result trends, evolution and distribution charts, statistics such as, CP/CPK, sigma, range and variance.

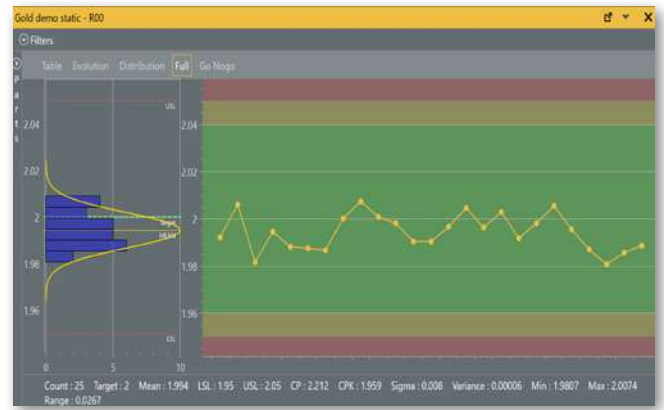
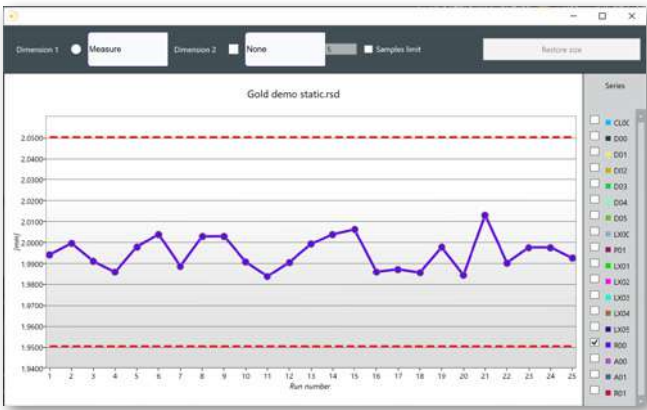

INTEGRATED MEASUREMENT

For additional measurements not covered by our SCAN machine, such as an internal diameter, Sylvac can provide a selection of instrument, such as calipers, indicators and internal micrometers.

These Sylvac instruments can be linked to the SCAN machine via our renowned *Bluetooth®* technology, providing a complete part measurement all in one report and sequence.

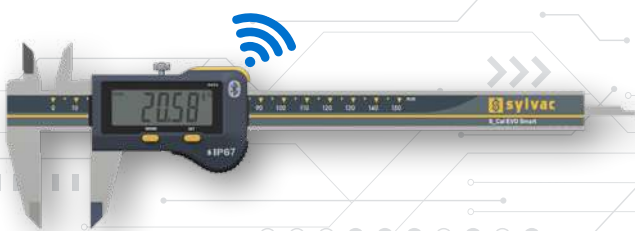

Exclusive Tilt system

FOR MORE COMPREHENSIVE THREAD MEASUREMENTS

The Sylvac-Scan machines equipped with the additional tilt 'T' axis (S25T/S65T) offer the ultimate measurement solution for threaded parts.

Thanks to our unique tilting optics, the thread can be scanned according to the helix angle, revealing elements of the thread which would otherwise be hidden. Sylvac-Scan offers true thread measurement.

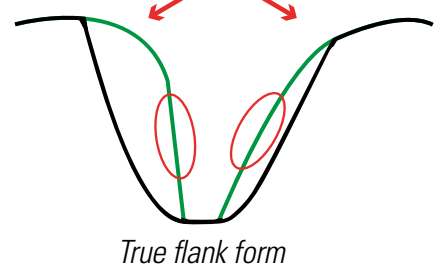
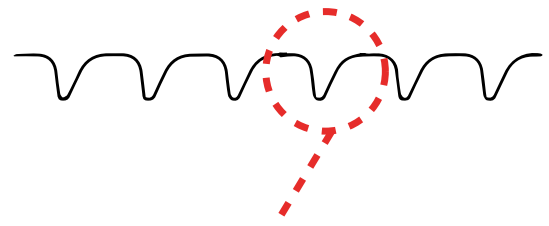
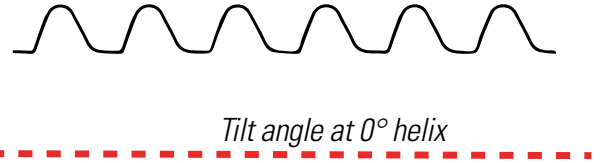

TYPICAL MEASUREMENT REQUIREMENTS:

- Major diameter
- Minor diameter
- Pitch
- Pitch diameter
- Flank angles
- Root & Crest radius
- Taper angle
- Circularity
- Run-out
- Concentricity

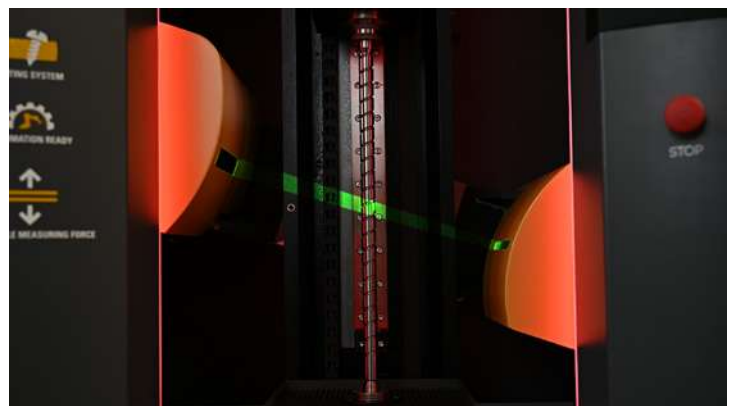

Axis inclination on S65T

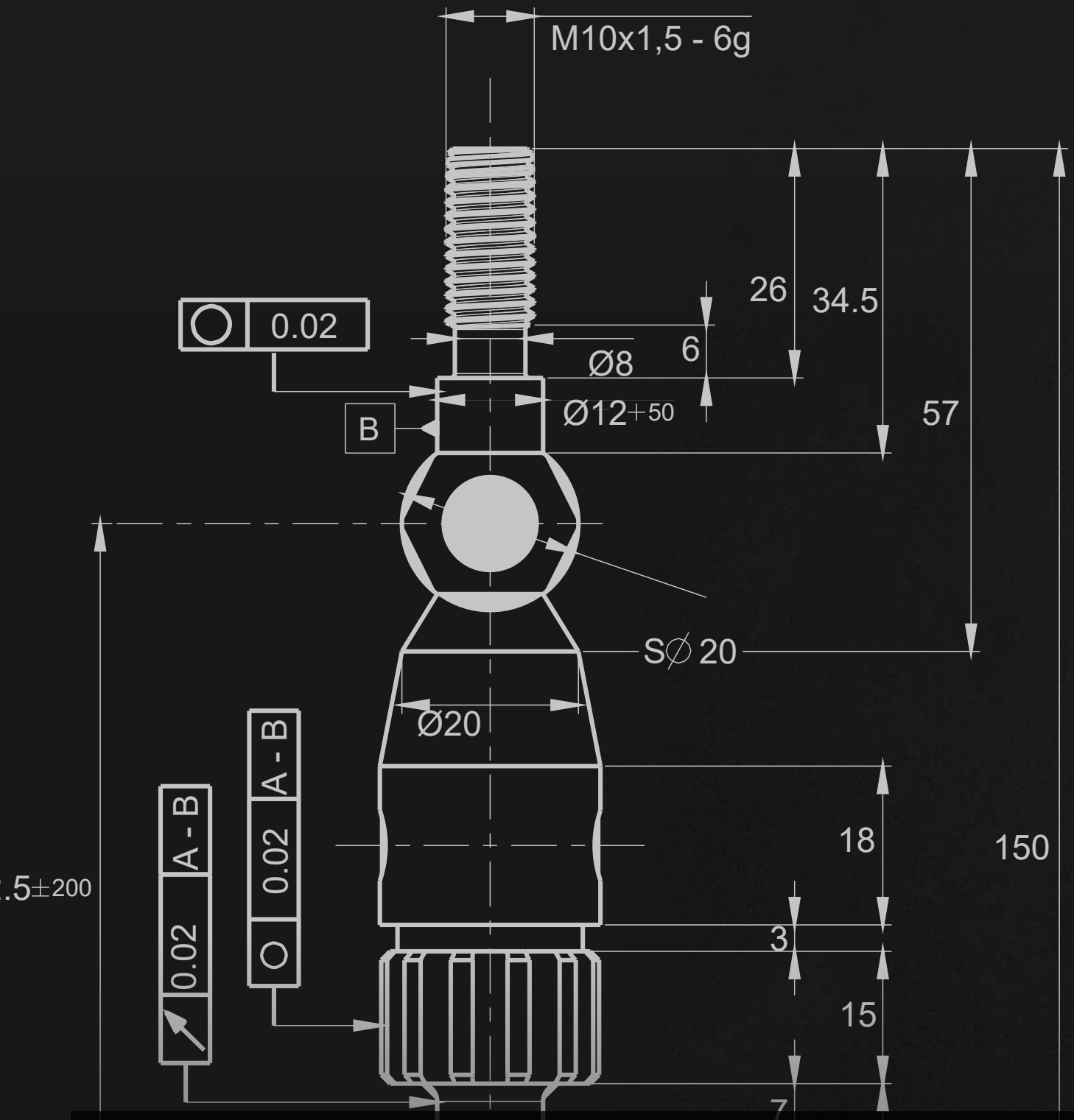

At the cutting-edge of technology



1 CLICK
200 RATINGS
10 SECONDS



**CHECK OUT
THE VIDEO !**

Software features



CAD Software

CAD import/export

Advanced thread measurement

Advanced dust filtering



Access management- security level

Customisable operator interface

Formula wizard

Script function

BT Connectivity to Sylvac instruments

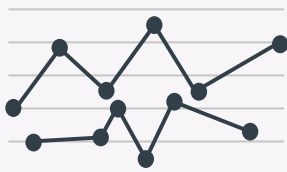

Easy to read results

Data export

Statistic view

Reports editor

Off-line programming

Automatic part/program recognition



Easy to use

Automatic measurement of the main features

One-click measurement

Sylvac SCAN S25 & S25T



- Bench top machine for smaller parts
- Integrated operator touch screen control panel
- Integrated calibration master & temperature sensors for environmental control
- Quick and easy accessory changing system
- High definition optics suited to micro parts
- Reflex click technology
- Tilt axis for advanced thread measurement
- Advanced software features
- Fully equipped «Automation Ready»
- Motorised tailstock
- High resolution sensor for intricate features

TECHNICAL SPECIFICATIONS

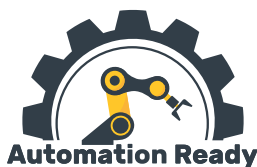

		902-4020 - SCAN S25		902-4025 - SCAN S25T	
		Diameter	Length	Diameter	Length
Measuring range	mm	26	200	26	200
Resolution	mm	0.0001			
Accuracy	µm	Diameter : 0.9 + (D[mm]/100) / Length : 2.5 + (L[mm]/200)			
Repeatability 2σ	µm	Diameter : 0.5 / Length : 0.8			
Holding capacity	mm	51	200	51	200
Tilting for thread measurement		-		✓ 30°	
Axial move speed up to	mm/s	100			
Max. part weight	kg	3			
Machine weight	kg	73			

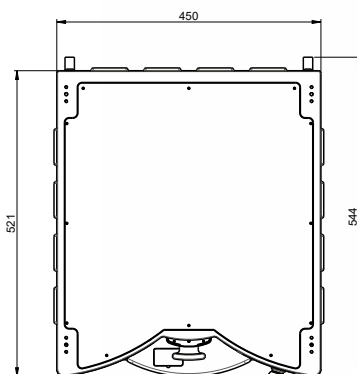

DELIVERY

- Machine according to technical specifications
- Computer with screen, keyboard and mouse
- Windows multilingual operating system
- Sylvac Reflex SCAN Software +
- Accessories : 2x 902-6259 ISO / MK2 adapter, 2x 902-6202, 902-6161 & 902-6212
- Manual

Sylvac SCAN S65(T), S65L(T)

- Optical machine for cylindrical parts up to Ø65mm
- Integrated operator touch screen control panel
- integrated calibration master & temperature sensors for environmental control
- Retractable roof for heavy parts loading
- Next generation of optical technology
- Reflex click technology
- Optional tilt axis for advanced thread measurement
- Advanced software features
- Fully equipped «Automation Ready»
- Motorised tailstock
- Quick release tooling



TECHNICAL SPECIFICATIONS



		902-4260 - SCAN S65		902-4265 - SCAN S65T		902-4262 - SCAN S65L		902-4267 - SCAN S65LT	
		Diameter	Length	Diameter	Length	Diameter	Length	Diameter	Length
Measuring range	mm	65	350	65	350	65	700	65	700
Resolution	mm	0.0001							
Accuracy	µm	Diameter : 1.0 + (D[mm]/100) / Length : 3 + (L[mm]/200)							
Repeatability 2σ	µm	Diameter : 0.5 / Length : < 1							
Holding capacity	mm	200	360	200	360	200	710	200	710
Tilting for thread measurement		-		✓ 30°		-		✓ 30°	
Axial move speed up to	mm/s	160							
Max. part weight	kg	60							
Machine weight	kg	420				500			

DELIVERY

- Machine according to technical specifications delivered with screen support
- Computer with screen, keyboard and mouse
- Windows multilingual operating system
- Sylvac Reflex SCAN Software +
- Accessories : 2x 902-6259 ISO / MK2 adapter, 2x 902-6202, 902-6161 & 902-6212
- Manual

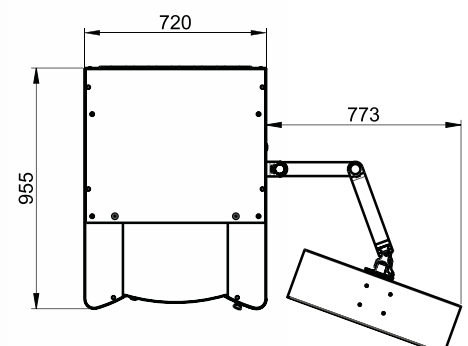

Sylvac SCAN S145, S145L & S145XL



- Free standing machine for larger parts with heavy weight loads
- Automation ready
- Removable roof for heavy part loading
- Motorised tailstock
- Quick release tooling
- LED status light
- Safety light curtain
- Integrated calibration master & temperature sensors for environmental control
- Reflex click technology
- Advanced software features
- Optional custom scripts

TECHNICAL SPECIFICATIONS



		902-4145 - SCAN S145		902-4147 - SCAN S145L		902-4148 - SCAN S145XL	
		Diameter	Length	Diameter	Length	Diameter	Length
Measuring range	mm	145	615	145	1280	145	1800
Resolution	mm	Diameter : 0.0001 / Length : 0.0001					
Accuracy	µm	Diameter : 1.5 + (D[mm]/100) / Length : 4 + (L[mm]/200)					
Repeatability 2σ	µm	Diameter : 0.5 / Length : 1.0					
Holding capacity	mm	254	615	254	1280	254	1800
Rotary headstock		✓					
Axial move speed up to	mm/s	160					
Max. part weight	kg	100					
Machine weight	kg	530		650		797	

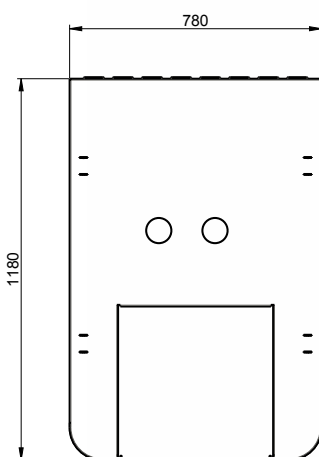

DELIVERY

- Machine according to technical specifications
- Adaptor for Morse 2 (902-6260) and accessories 902-6210 and 902-6380
- Table 350mm, 700mm optional, 902-6611 (not on XL)
- Windows multilingual operating system
- Sylvac Reflex SCAN+ Software
- Machine stand with screen and keyboard holder
- Manual



Now with 3D probe.

High-precision measurement of runo

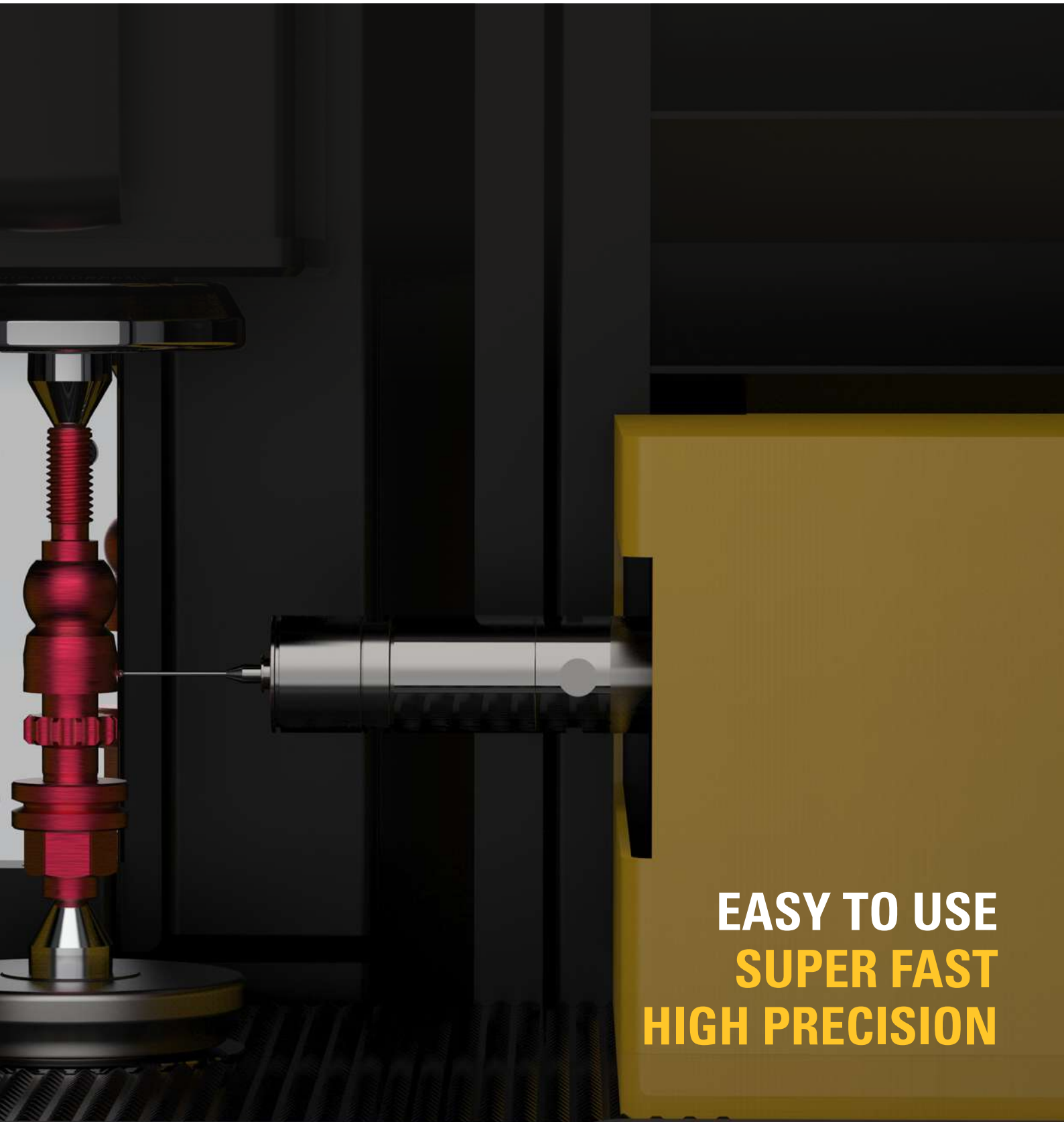

EASY TO USE
SUPER FAST
HIGH PRECISION

out, form and internal features.

Sylvac SCAN S145-P, S145L-P & S145XL-P

- Complete measurement with a single system
- Seamless integration with combined sensor measurements
- Easy programming thanks to user-friendly functions
- Full touch probe scanning capability for measuring form
- Interchangeable probe stylus for increased access
- Automated probe qualification routine
- Typical measurements include : hole and slot size, location and form, roundness, radial and axial runout



TECHNICAL SPECIFICATIONS

		902-4145-05 - SCAN S145-P		902-4147-05 - SCAN S145L-P		902-4148-05 - SCAN S145XL-P	
		Diameter	Length	Diameter	Length	Diameter	Length
Measuring range	mm	145	615	145	1230	145	1750
Resolution	mm	Diameter : 0.0001 / Length : 0.0001					
Accuracy	µm	Diameter : 1.5 + (D[mm]/100) / Length : 4 + (L[mm]/200)					
Repeatability 2σ	µm	Diameter : 0.5 / Length : 1.0					
Holding capacity	mm	200	615	200	1280	200	1800
Axial move speed up to	mm/s	160					
Max. part weight	kg	100					
Machine weight	kg	550		670		817	

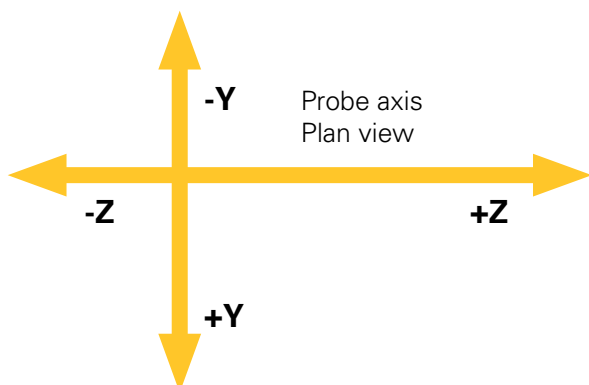

Touch probe measuring volume			
Axis	S145-P	S145L-P	S145XL-P
PX	615mm	1230mm	1750mm
PY	+60mm / -40mm		
PZ	130mm / -15mm		



Full 2D axis movement for uncompromised measurement

Renishaw SP25M probe

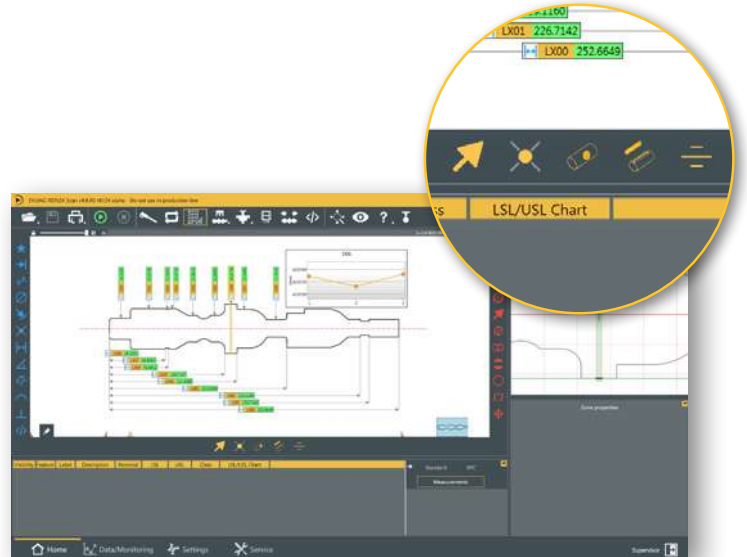

Main interface with 3D probe toolbar

TYPICAL MEASUREMENT FEATURES

Holes

- Size/diameter
- Depth
- Location
- Form
- Angular position

Slots/Keyway

- Length
- Width
- Depth
- Symmetry
- Location
- Form
- Angular position

Distances

- Length
- Diameter
- Undercuts*
- Grooves on diameter

Dynamic

- Radial runout
- Axial runout
- Roundness
- Cylindricity

* with appropriate stylus



Examples of parts requiring an extra touch

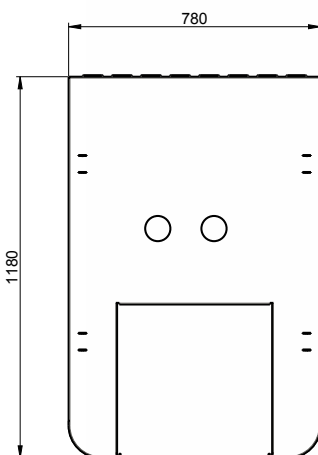

DELIVERY

- Machine according to technical specifications as standard machines S145, S145L or S145XL
- 1x SM25-1 Scanning module (902-5002)
- 2x SH25-1 Stylus holder (902-5003)
- 1x Ø1.5 mm x L30mm stylus (M3) (902-5010)

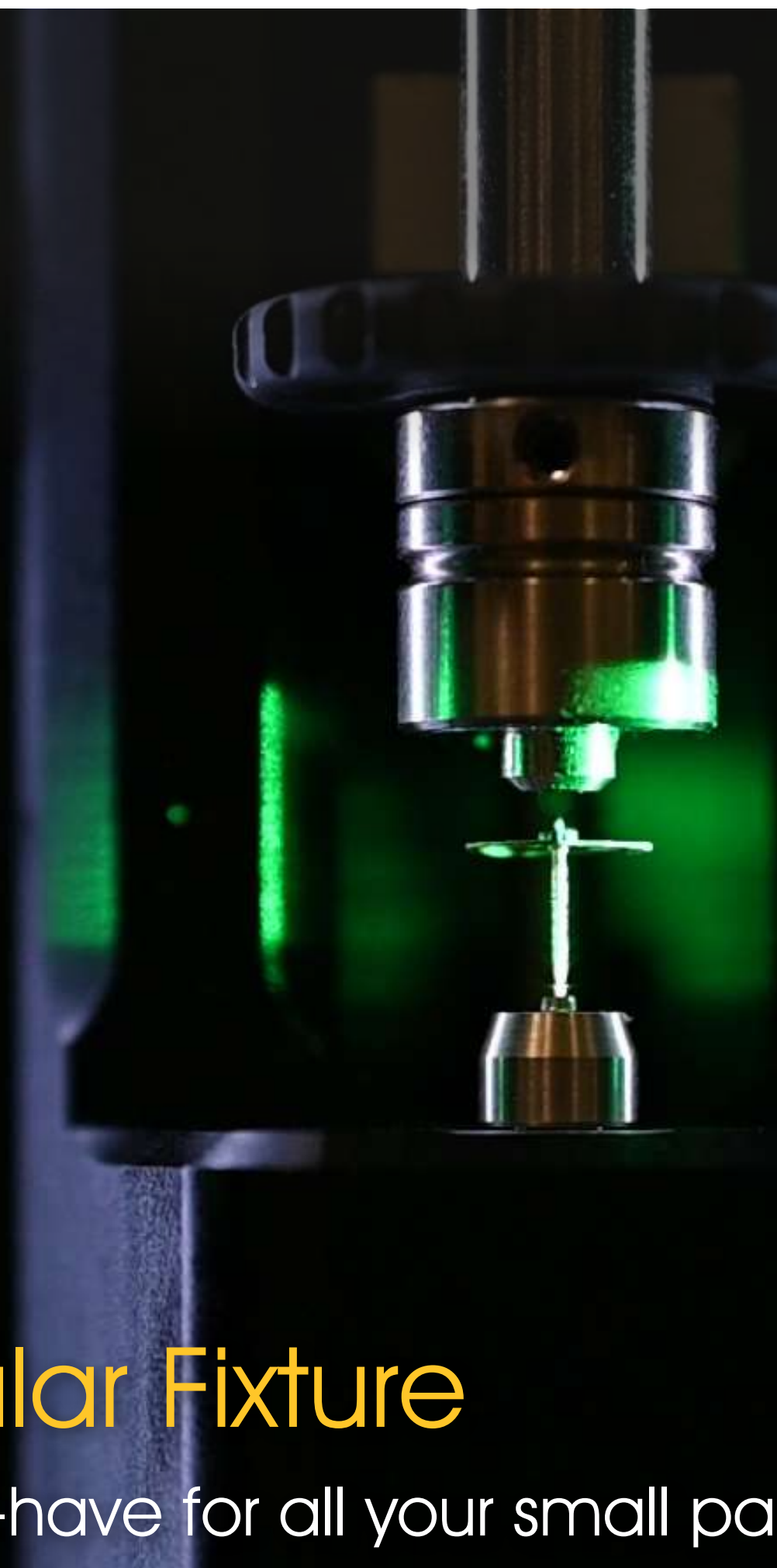

Modular Fixture

The must-have for all your small parts

SCAN MACHINES S25 / S25T

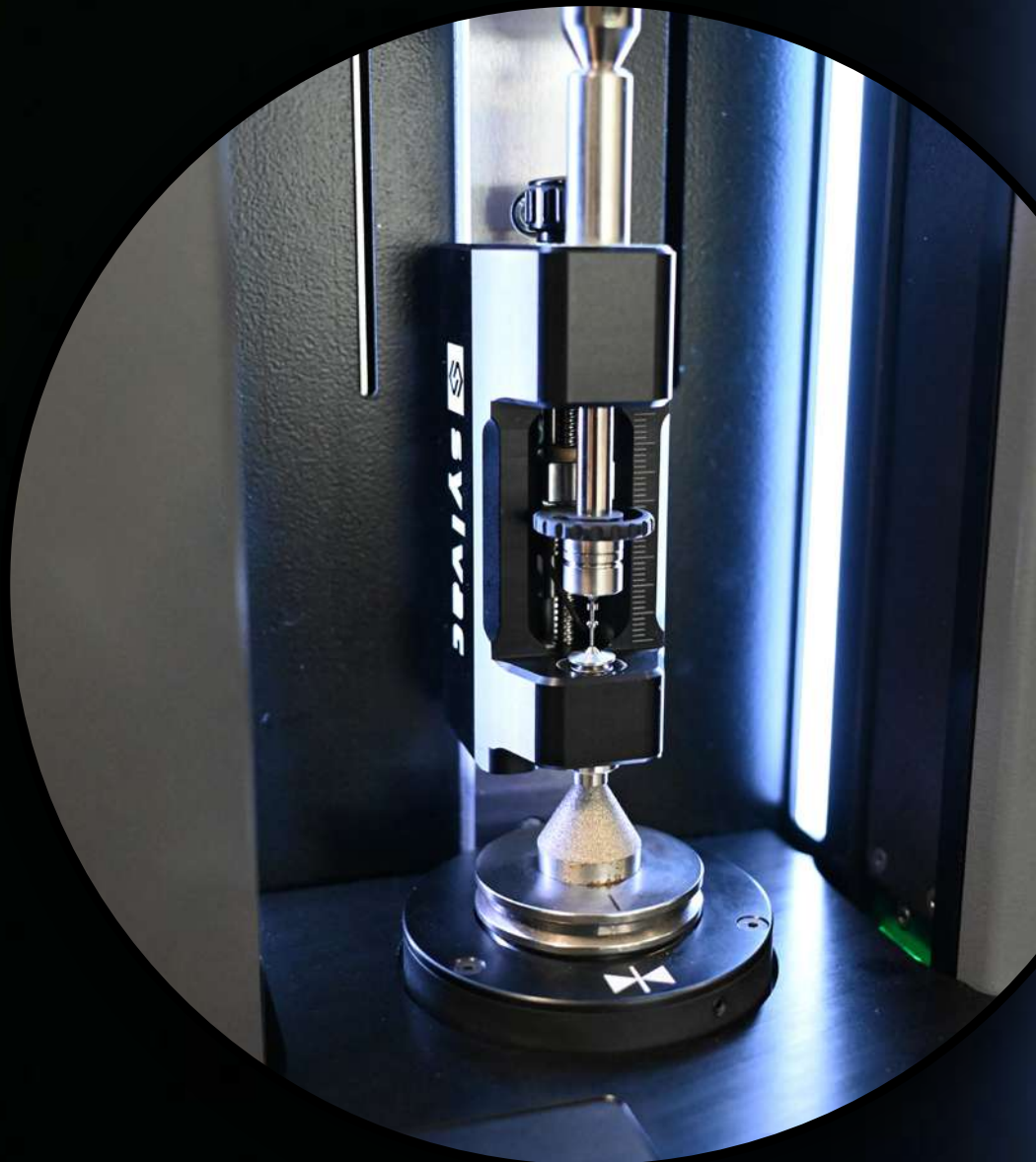

ts

Specifications of the softwares

FUNCTIONS	Sylvac RS+	Sylvac RS+ PRO	Sylvac RS+ EXPERT
Automatic measurement of the main features (diameters, lengths, angles, radius)	✓	✓	✓
Automatic parts / program recognition	✓	✓	✓
Reports editor	✓	✓	✓
Data export	✓	✓	✓
SPC basic calculation	✓	✓	✓
Access management - security level	Multiple	Multiple	Multiple
Off-line programming	Optional	Optional	Optional
Advanced dust filtering	✓	✓	✓
Statistic view	✓	✓	✓
CAD Import / Export / Compare		✓	✓
Script function		✓	✓
Monitoring SPC module		✓	✓
Thread wizard for custom threads		✓	✓
Parametric programs			✓
APC			✓

GEOMETRICAL TOLERANCING - FEATURES SUMMARY	Sylvac RS+	Sylvac RS+ PRO	Sylvac RS+ EXPERT
Diameters	✓	✓	✓
Lengths, heights, distances	✓	✓	✓
Angles, chamfers	✓	✓	✓
Radii	✓	✓	✓
Roundness	✓	✓	✓
Cylindricity	✓	✓	✓
Across flats	✓	✓	✓
Rotational diameters	✓	✓	✓
Run out	✓	✓	✓
Concentricity	✓	✓	✓
Threads (parallel)	✓	✓	✓
Threads taper	✓	✓	✓
Advanced threads (root detail, taper, multi-starts, worm screws,...)	✓ Tilt machines only	✓ Tilt machines only	✓ Tilt machines only
Custom threads (bone-screws, dental implants, etc.)		✓	✓
Perpendicularity	✓	✓	✓
Form deviation	✓	✓	✓
Straightness	✓	✓	✓
Interrupted parts (splines, turbines)	✓	✓	✓

Investment

SYLVAC SCAN MACHINES QUICK ROI

Because the return on investment is essential data to make sensible decisions, SYLVAC can help you calculate your estimated payback time. It will directly depend on the profile of your company and the expected use of the machine.

You can see for yourself that your return on investment will be less than than 6 months in most cases. Moreover, the quality of your measurements will be improved!



TRADITIONAL MANUAL METHODS USING MULTIPLE GAUGES :



10-30 min
INSPECTION TIME

SYLVAC-SCAN SERIES :



30-60 sec
INSPECTION TIME

Tailor-made solutions



CLAMPING SOLUTIONS FOR AUTOMATED SOLUTION

Apart from our standard range of fixtures, customised solutions can be developed to optimise your measuring process.

SOFTWARE

Thanks to the Reflex SCAN+ and its flexible open script option, custom software features and macros can be created.

MEASURING TURNED PARTS HAS NEVER BEEN SO EASY !

- Quality control for your shafts just got easier !
- The Sylvac-Scan range of optical measuring centres, now available fully automated
- Rapid automatic part loading/unloading by a robot, classification feedback for specified drop location
- Machine tool feedback for part correction / offsets with APC

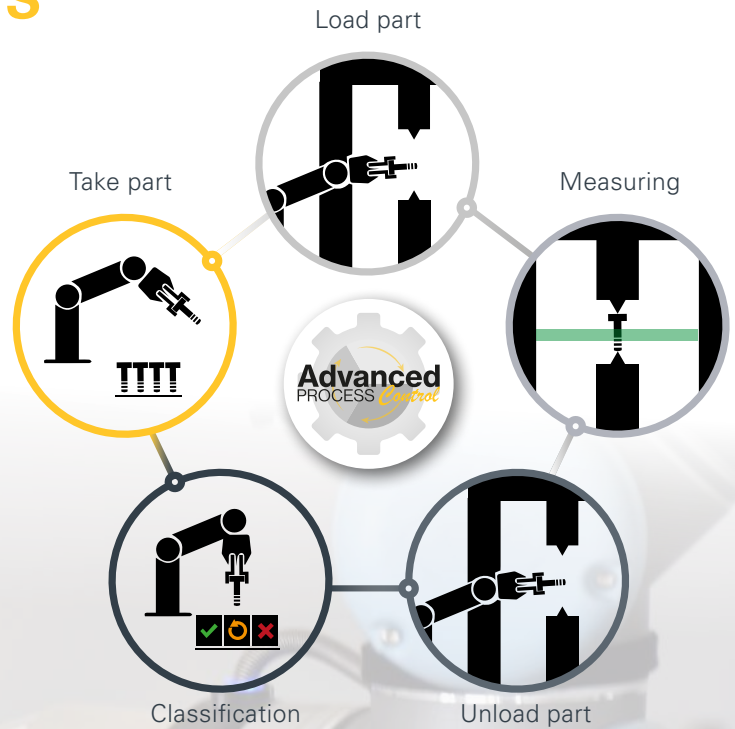

Example of SCAN S25T with robot



Applications



PACKAGING



COSMETICS



PLUMBING



PLASTICS

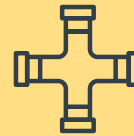

HYDRAULIC



PNEUMATIC



CONNECTORS



AUTOMOTIVE



AEROSPACE



INJECTION MOULDING



PHARMA



ELECTRO MOTORS



MUNITIONS



THREADS



WATCH INDUSTRY

We can measure all your components with our optical machines dedicated to the industry.

A close-up photograph of a precision mechanical assembly. The main component is a brass-colored metal piece with a threaded top section, a spherical joint, and a hexagonal base. It is mounted on a black metal block with a circular hole. To the right, a similar green-colored component is partially visible. The background is dark and out of focus.

Accessories



Centres, drive centres, manual chucks



cks, plates, pneumatic chucks, etc.

Accessories

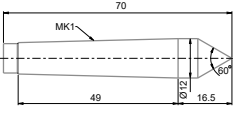
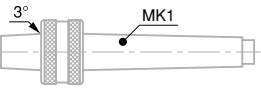
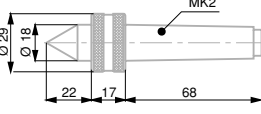
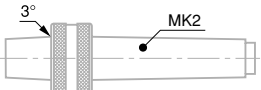
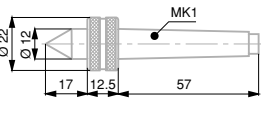
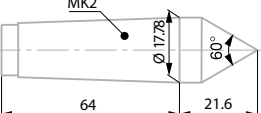
CENTRES AND DRIVE CENTRES

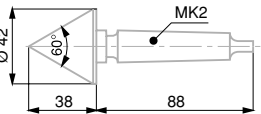
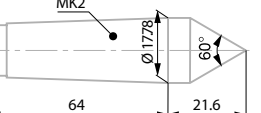
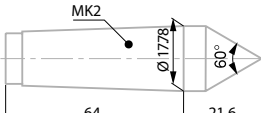
		S25/S65	Morse 2 F60	S145	
	902-6000	Male centre 10 mm MK1	Requires 902-6258	Requires 902-6360	Requires 902-6360
	902-6160	Rotation centre with a B12 male taper plus a Morse 1 taper shank	Requires 902-6258	Requires 902-6360	Requires 902-6360
	902-6161	Rotation centre, Morse 2			
	902-6162	Rotation centre with a B18 male taper plus a Morse 2 taper shank			
	902-6163	Rotation centre, Morse 1	Requires 902-6258	Requires 902-6360	Requires 902-6360
	902-6202	Male centre 17.78 mm, extra (Standard delivery with Sylvac-SCAN S25, S65 and S145)			
 IMAGE SOON AVAILABLE	902-6203	Drive centre (Diamond coated 10mm)	Requires 902-6258	Requires 902-6360	Requires 902-6360
	902-6210	Drive centre, Ø 42 mm plus a Morse 2 taper shank Diamond coated			
	902-6211	Non diamond coated Drive centre Ø 42mm			
	902-6212	Centre MK2 diamond coated, Ø 17mm			

Accessories

INVERTED V-CENTRES

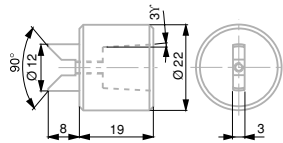
**902-6206**

Rotating female centre Ø10mm
Capacity Ø3 - 10mm

•
Requires
902-6360
902-6160

•
Requires
902-6360
902-6160

•
Requires
902-6360
902-6160

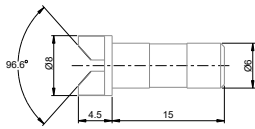
**902-6214**

Female centre Ø1.7 - 5.4mm

•
Requires
902-6251

•
Requires
902-6251

•
Requires
902-6251

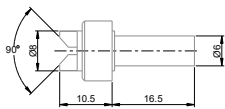
**902-6215**

Rotating female centre Ø1.7 - 5.4mm

•
Requires
902-6251

•
Requires
902-6251

•
Requires
902-6251

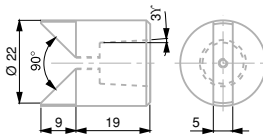
**902-6207**

Rotating female centre Ø20mm
Capacity Ø5 - 20mm

•
Requires
902-6360
902-6160

•
Requires
902-6360
902-6160

•
Requires
902-6360
902-6160

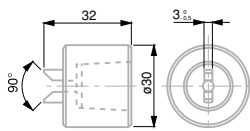
**902-6310**

Female centre Ø10mm
Capacity Ø3 - 10mm

•
Requires
902-6162

•
Requires
902-6162

•
Requires
902-6162

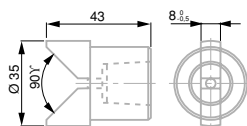
**902-6311**

Rotating female centre Ø30
Capacity Ø5 - 30mm

•
Requires
902-6162

•
Requires
902-6162

•
Requires
902-6162

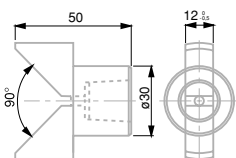
**902-6312**

Female centre Ø45mm

•
Requires
902-6162

•
Requires
902-6162

•
Requires
902-6162

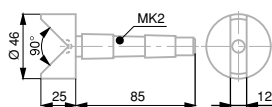
**902-6340**

Female centre Ø40mm MK2
Capacité Ø5 - 40mm

•

•

•

MANUAL CHUCKS

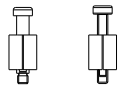
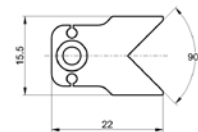
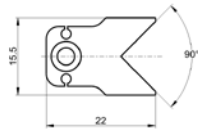
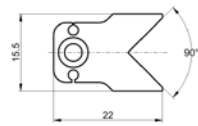
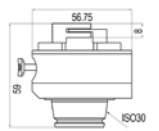
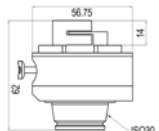
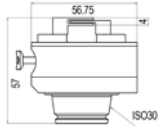
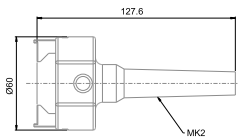
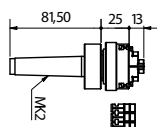
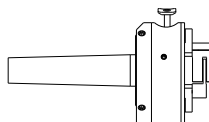
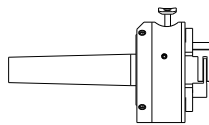
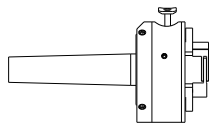
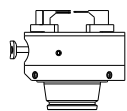

IMAGE SOON AVAILABLE



		S25/S65	Morse 2 F60	S145
902-6222	External 2-jaw gripper MK2		●	● Requires 902-6260
902-6270	Two-jaw pliers Ø 0-20 mm with H=4mm jaws (only the left jaw is exchangeable)	●		
902-6271	Two-jaw pliers Ø 0-20mm with H=8mm jaws (only the left jaw is exchangeable)	●		
902-6272	Two-jaw pliers Ø 0-20mm with jaws H=14mm (only the left jaw is exchangeable)	●		
902-6273	Left external jaws Ø 0-20mm H=4mm	For 902-6267, 902-6268, 902-6269 902-6270, 902-6271 and 902-6272	For 902-6267, 902-6268, 902-6269 902-6270, 902-6271 and 902-6272	For 902-6267, 902-6268, 902-6269 902-6270, 902-6271 and 902-6272
902-6274	Left external jaws Ø 0-20mm H=8mm	For 902-6267, 902-6268, 902-6269 902-6270, 902-6271 and 902-6272	For 902-6267, 902-6268, 902-6269 902-6270, 902-6271 and 902-6272	For 902-6267, 902-6268, 902-6269 902-6270, 902-6271 and 902-6272
902-6275	Left external jaws Ø 0-20mm H=14mm	For 902-6267, 902-6268, 902-6269 902-6270, 902-6271 and 902-6272	For 902-6267, 902-6268, 902-6269 902-6270, 902-6271 and 902-6272	For 902-6267, 902-6268, 902-6269 902-6270, 902-6271 and 902-6272
902-6276	Jaw raiser, H=10mm Stackable, maximum 2x10mm (for gripper 902-6270, 902-6271, 902-6272)	For 902-6267, 902-6268, 902-6269 902-6270, 902-6271 and 902-6272	For 902-6267, 902-6268, 902-6269 902-6270, 902-6271 and 902-6272	For 902-6267, 902-6268, 902-6269 902-6270, 902-6271 and 902-6272
902-6288	Jaw raiser, H=50mm (for gripper 902-6270, 902-6271, 902-6272)	For 902-6267, 902-6268, 902-6269 902-6270, 902-6271 and 902-6272	For 902-6267, 902-6268, 902-6269 902-6270, 902-6271 and 902-6272	For 902-6267, 902-6268, 902-6269 902-6270, 902-6271 and 902-6272
902-6278	Two-jaw pliers Ø 0-7mm with H=1.5mm jaws	●		
902-6267	Two-jaw pliers Ø 0-20mm MK2 with H=4mm jaws (only the left jaw is exchangeable, delivered in pairs)		●	● Requires 902-6260
902-6268	Two-jaw pliers Ø 0-20mm MK2 with H=8mm jaws (only the left jaw is exchangeable)		●	● Requires 902-6260
902-6269	Two-jaw pliers Ø 0-20mm MK2 with jaws H=14mm (only the left jaw is exchangeable)		●	● Requires 902-6260
902-6306	3-jaw chuck MK2 External clamping Ø 0.5mm - 41mm Internal clamping Ø 12mm - 36mm Step Height : 5mm	●	●	● Requires 902-6260

Accessories

MANUAL CHUCKS

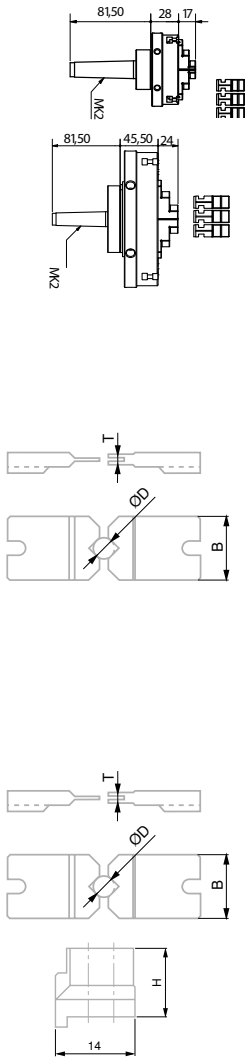

		S25/S65	Morse 2 F60	S145
902-6307	3-jaw chuck MK2 External clamping Ø 1mm - 71mm Internal clamping Ø 18mm - 66mm Step Height : 10mm	•	•	
902-6308	3-jaw chuck ISO40 External clamping Ø 1mm - 150mm Internal clamping Ø 34mm - 174mm Step Height : 10mm			•
902-6140 6÷12mm / T=15mm	External jaws, in pairs	For 902-6220, 902-6221, 902-6222, 902-6223	For 902-6220, 902-6221, 902-6222, 902-6223	For 902-6220, 902-6221, 902-6222, 902-6223
902-6141 0÷6mm / T=1.5mm				
902-6142 0÷6mm / T=3mm				
902-6143 6÷12mm / T=3mm				
902-6144 12÷18mm / T=6mm				
902-6145 18÷24mm / T=9mm				
902-6152 0÷6mm / T=6mm				
902-6153 0÷6mm / T=15mm	External jaws, in pairs	Requires 902-6220, 902-6221, 902-6222, 902-6223	Requires 902-6220, 902-6221, 902-6222, 902-6223	Requires 902-6220, 902-6221, 902-6222, 902-6223
Set with 5 articles 902-6154 H=22				
902-6231	Raising blocks for external jaws, in pairs	Requires 902-6220, 902-6221, 902-6222, 902-6223	Requires 902-6220, 902-6221, 902-6222, 902-6223	Requires 902-6220, 902-6221, 902-6222, 902-6223

AUTOMATIC CHUCKS

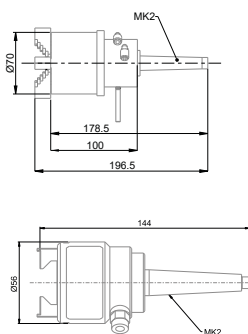

		S25/S65	Morse 2 F60	S145
902-6309	3-jaw pneumatic chuck MK2 1mm - 60mm		•	
902-6223	2-jaw pneumatic chuck MK2	•	•	
902-6290	Automatic version of 2-jaw gripper (902-6270)	•		

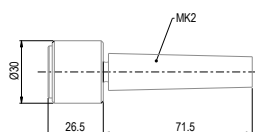
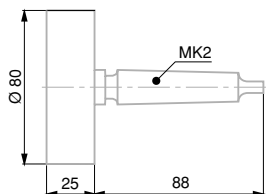
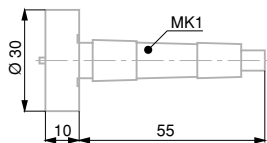
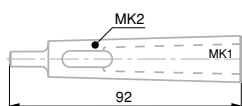
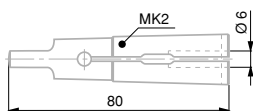
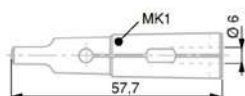
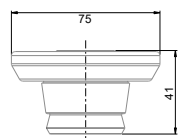
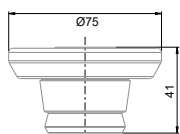
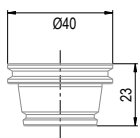

IMAGE SOON AVAILABLE

PLATES



902-6208	Plate, Ø 30 mm MK1	• Requires 902-6258	• Requires 902-6360	• Requires 902-6360
902-6209	Plate, Ø 80 mm MK2	•	•	•
902-6228	Magnetic clamping plate Ø0-24 mm MK2	•	•	•

ADAPTERS



		S25/S65	Morse 2 F60	S145
902-6258	Adapter MK1 for SCAN S25	•		
902-6259	Adapter MK2 for SCAN S25	•		
902-6260	Adapter MK2 for SCAN S145			•
902-6263	Adapter MK3 for SCAN S145			•
902-6250	Adapter with bore Ø 6 mm MK1	• Requires 902-6258	• Requires 902-6360	• Requires 902-6360
902-6251	Adapter with bore Ø 6 mm MK2	•	•	•
902-6360	Reduction sleeve DIN 2185 MK A/I 2:1	•	•	•

Accessories

SOFTWARE OPTIONS



		F60	S145	S25/S65
***	Reflex SCAN+ Standard (delivered with 902-4060, 902-4062, 902-4065, 902-4067, 902-4020 & 902-4025)	•	•	•
902-7015	Reflex SCAN+ Offline Software	•	•	•
902-7021	Reflex-Scan+ «PRO» including, advanced thread wizard, CAD compare, Monitoring SPC, scripting	•	•	•
902-7022	Reflex-SCAN+ PRO Offline	•	•	•
902-7023	Reflex SCAN+ Expert	•	•	•
902-7024	Reflex SCAN+ Expert Offline	•	•	•
902-7025	Reflex SCAN+ Expert upgrade from PRO	•	•	•

GRIPPING OF SMALL PARTS

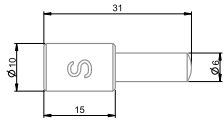

902-6330

Centered magnetic plate, magnetized - SUD
for the headstock

F60

S145

S25/S65

- Requires 902-6251

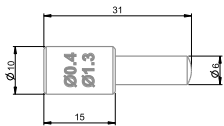

902-6335

Magnetic gripper with V for parts with
Ø0.4mm - 1.3mm tip, magnetized - NORD

- Requires 902-6251

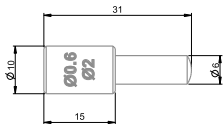

902-6336

Magnetic gripper with V for parts with
Ø0.6mm - 2.0mm tip, magnetized - NORD

- Requires 902-6251

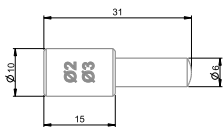

902-6337

Magnetic gripper with V for parts with
Ø2.0mm - 3.0mm tip, magnetized - NORD

- Requires 902-6251



902-6339

Set of 3 NORTH magnetic plates
(902-6335, 902-6336, 902-6337) and
1 SOUTH magnet (602-6330)

- Requires 902-6251

Modular Fixture for micro parts

- Discover our brand-new modular Fixture micro-parts for our **Sylvac-SCAN S25 and S25T machines**, for static and dynamic measurements on cylindrical parts. No special settings are required. Parts can be loaded on a horizontal work surface or directly onto the machine.
- Easy loading of small parts
- Pre-loading saves time
- Inter-tip force reduced to almost zero



TECHNICAL SPECIFICATIONS

		902-6242
Length measurement capacity	mm	0-25
Diameter measurement capacity	mm	Ø0 -> Ø20
Static measurement		✓
Dynamic measurement		✓
Repeatability (magnetized part)	mm	< 0.010 (dynamic measurement)
Repeatability (non-magnetic part)	mm	< 0.0025 (dynamic measurement)

EXAMPLES OF PARTS TO BE MEASURED



L=78mm
 Ø max= 2mm
 Ø min= 0.3mm



L=3.3mm
 Ø max=3.3mm
 Ø min=0.2mm



L=8mm
 Ø max=0.8mm
 Ø min=0.25mm

FIXTURES

- Customizable to your needs
- Interchangeable tips
- Magnetic and non-magnetic tips



STANDARD TIPS AND ACCESSORIES

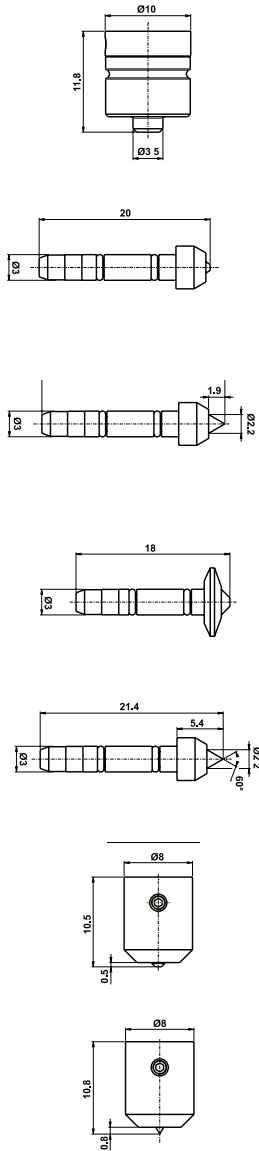

902-6243	Upper magnetic plate SOUTH
902-6244	Bottom female Magnetic Center
902-6245	Bottom male Magnetic Tip
902-6246	Bottom Non-Magnetic female Center
902-6247	Bottom Non-Magnetic Tip
902-6248	Female rotating upper center
902-6249	Male rotating upper tip

*For use only with modular installation on SCAN S25 or S25T.
Customized end caps on request.*

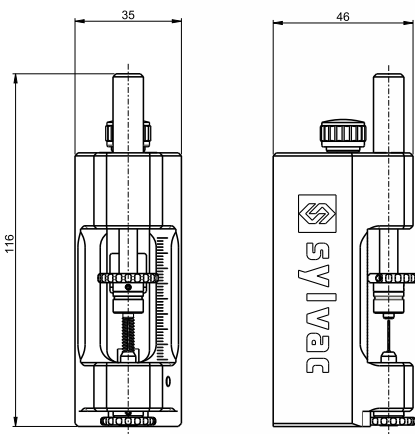

DELIVERY

- Instruments to technical specifications
- Supplied without tips

OTHER ACCESSORIES







			F60	S145	S25/S65
	902-6012	Gold demo part	•	•	•
	902-6013	Gold demo part for threads	•	•	•
	902-6014	Gold demo part XL		•	
	902-6600	Table for Sylvac SCAN F60 (85x85x70cm)	•		•
	902-6601	Furniture for Sylvac SCAN F60 storage for PC, drawer with lock and arm for keyboard and screen	•		
	902-6602	Table for Sylvac-Scan S25T (75cmx75cm) selectable height 75cm or 105cm			•
	902-6605	Height-adjustable table (71-1140mm) for keyboard, screen and mouse (80x60mm)	•		•



IMAGE SOON AVAILABLE

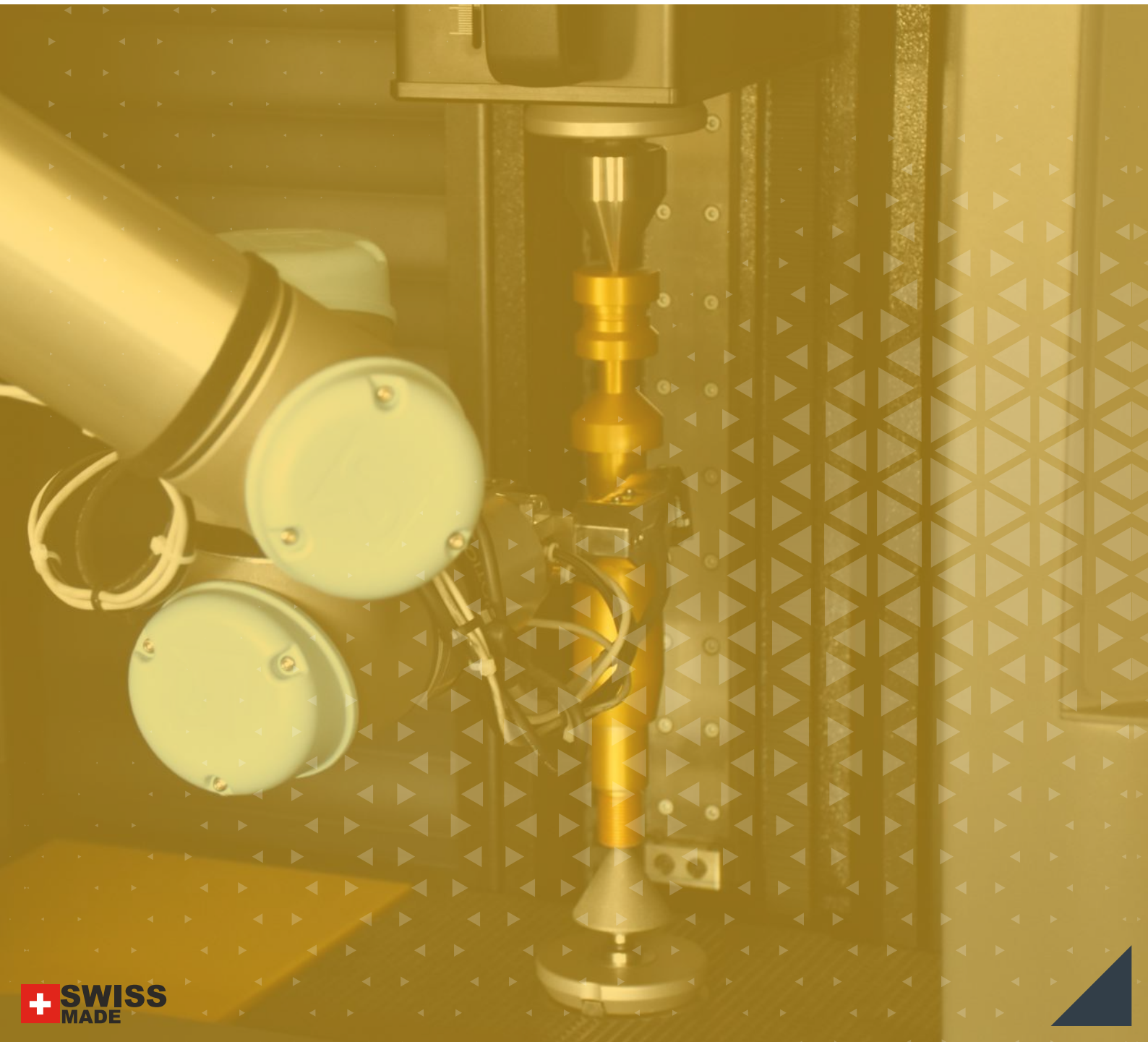

IMAGE SOON AVAILABLE



IMAGE SOON AVAILABLE

		F60	S145	S25/S65
902-6607	Accessories tidy insert for drawer (included with 902-6601)	•		
902-6006	Plastiform case for SCAN and VISIO	•	•	•
902-6609	Rack	•	•	•
902-6611	Option table 700mm (replaces the standard 350mm table)		•	
902-6613	Scan-S65/T machine stand H=600mm			• S65(T) series only
902-6614	Scan-S65L/LT machine stand H=350mm			• S65L(T) series only
602-104-01	Protective cover			•



SYL2106-LSCAN-E / 18.11.2025

Sylvac SA

Avenue des Sciences 19, 1400 Yverdon-les-Bains

Tel : +41 21 637 67 57

Web : www.sylvac.ch

Email. sales@sylvac.ch